

In-house Rapid PCB Prototyping



PRODUCT CATALOG

Circuit Board Plotters

Laser Circuit Structuring

Through-Hole Conductivity

Multilayer Prototyping

SMT/Finishing

Technical Guide

www.lpkf.com

LPKF[®]
Laser & Electronics

Placing an order? Need technical support? No problem!

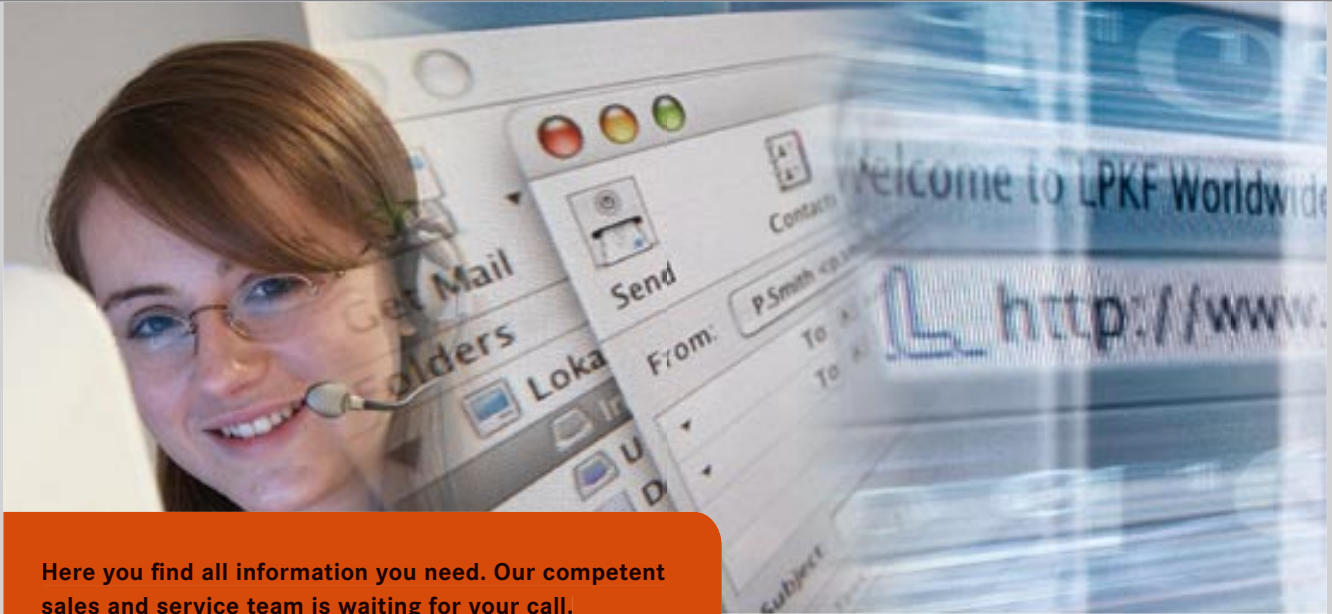

Here you find all information you need. Our competent sales and service team is waiting for your call.

LPKF Sales and Service

Europe (LPKF Headquarters)

Phone and Fax

Phone +49 (0) 5131-7095-0
Fax +49 (0) 5131-7095-90

E-mail

rp.sales@lpkf.de
rp.support@lpkf.de

LPKF website

www.lpkf.de
www.lpkf.com

North/Central America

Phone and Fax

Phone +1 (503) 454-4219
Fax +1 (503) 682-7151

E-mail

sales@lpkfusa.com
support@lpkfusa.com

LPKF website

www.lpkfusa.com

China

Phone and Fax

Sales Phone +86-13920308369
Service Phone +86-13032289111
Fax +86-2223006965

E-mail

sales@lpkf.cn

LPKF website

www.lpkf.cn



Worldwide LPKF distribution partners

LPKF maintains a worldwide distribution network. Find the most convenient one on **page 108**, or visit **www.lpkf.com** for more information.

Welcome to LPKF's world of Rapid PCB Prototyping

Thank you for your interest in LPKF Laser & Electronics. This catalog contains the latest data and information to help you review and choose the best technological solution to all your rapid prototyping needs: machines, tools, applications, consumables, accessories and software. This new catalog also contains the Technical Guide, a collection of tips and tricks for using LPKF hardware and software to achieve the best results.

Why in-house prototyping?

In-house PCB prototyping is simply the only way to stay ahead of competition with the lightning pace of today's technology. In-house prototyping lets engineering and research groups build a prototype, test it, modify the design, and construct a new prototype – in a fraction of the time required by an outside prototyping house. Depending on the complexity of the prototype, a single shift might see several development cycles.

Security is also a huge factor, and in-house prototyping keeps all design work in the engineering lab where it belongs. No external vendors, no couriers, no one outside the lab sees the data.

In addition to speed and security, probably the simplest benefit to in-house prototyping is the convenience. There's

nothing to compare with the convenience of having a production-quality board manufacturing house right there in the middle of the engineering department or research lab. LPKF products create single layer boards, multilayer boards, power boards, RF and microwave boards, boards on solid substrate, boards on flexible substrate, and even non-PCB products, such as stencil masks, polyimide films, plastics and metals, and a variety of other applications – all on the desktop.

Company

With over thirty years of experience helping customers meet or exceed their engineering needs, LPKF remains a world leader in the field of rapid PCB prototyping. More than 250 employees maintain a worldwide distribution and service network.

LPKF[®]
Laser & Electronics
Distributor Meeting



Contents

Circuit Board Plotters

Page 4

Introduction to rapid PCB structuring and drilling	6
LPKF Plotters	
LPKF ProtoMat S100	
High-performance for RF and microwave applications	7
LPKF ProtoMat S62	
Advanced PCB prototyping for most applications	11
LPKF ProtoMat S42	
Rapid PCB prototyping in an entry-level package	15
LPKF ProtoMat H100	
High-performance PCB prototyping for all applications..	19
LPKF ProtoMat M60 and X60	
Reliable PCB prototyping for large working areas	23
Feature comparison	27
Accessories and options	29
Tools	33
Consumables	37
Software	41



Plotters

Laser

Laser Circuit Structuring

Page 44

LPKF ProtoLaser 200	
Direct laser structuring of circuit boards	44
Application notes for the LPKF ProtoLaser 200	49



Plating

Multilayer

Through-Hole Conductivity/Plating

Page 50

Introduction to through-hole plating	50
LPKF ProConduct®	
In-house PCB through-hole conductivity without chemicals	51
LPKF Contac III and MiniContac S	
Professional stand-alone electroplating tanks	55
LPKF EasyContac	
Manual through-hole conductivity for two-layer PCBs	59
Comparison of through-hole conductivity solutions	61



SMT/Finishing

Tech Guide

Index

Multilayer Prototyping

Page 62

Introduction to multilayer PCB production..... 62
LPKF MultiPress II
 Bench-top pneumatic press for multilayer PCBs 63
 Special notes for multilayer board production 65



Surface Mount Technology/Finishing

Page 66

Introduction to SMT prototyping..... 66
LPKF ProMask and ProLegend
 In-house screenprinting and solder-resist masks..... 67
LPKF ZelPrint LT300
 SMT solder paste printer 71
LPKF ProtoPlace
 Pick & Place assembly system 75
LPKF ProtoFlow
 Lead-free reflow oven ideal for in-house rapid PCBprototyping..... 79
 Review of rapid PCB prototyping for SMT circuitry..... 81



Technical Guide

Page 88

Base material, an overview 89
 Application review and compatibility grid 90
 CAM Software, LPKF CircuitCAM..... 92
 Machine control software, LPKF BoardMaster..... 93
 Building a basic 2-sided PCB prototype, step-by-step 94
 Chemical free through-hole plating, step-by-step 95
 Galvanic through-hole plating, step-by-step 96
 A 6-layer multilayer PCB, step-by-step 97
 LPKF ProMask professional solder mask, step-by-step..... 98
 Surface Mount Technology (SMT), step-by-step 99
 Microwave and RF application notes 100
 Plastic and aluminum engraving 101

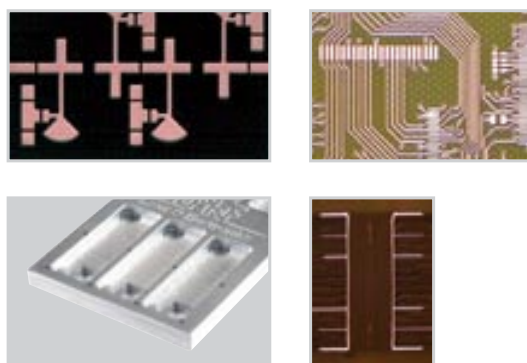

Other LPKF technical solutions..... 84
Glossary 102
Catalog index 106
LPKF distributors worldwide 108
Order request form sheet..... 109
Indicia..... 113

Plotters

Laser

Plating

Multilayer

SMT/Finishing

Tech Guide

Index

LPKF circuit board plotters

for in-house manufacturing of prototype and small-batch printed circuit boards

- Plotters
- Laser
- Plating
- Multilayer
- SMT/Finishing
- Tech Guide
- Index

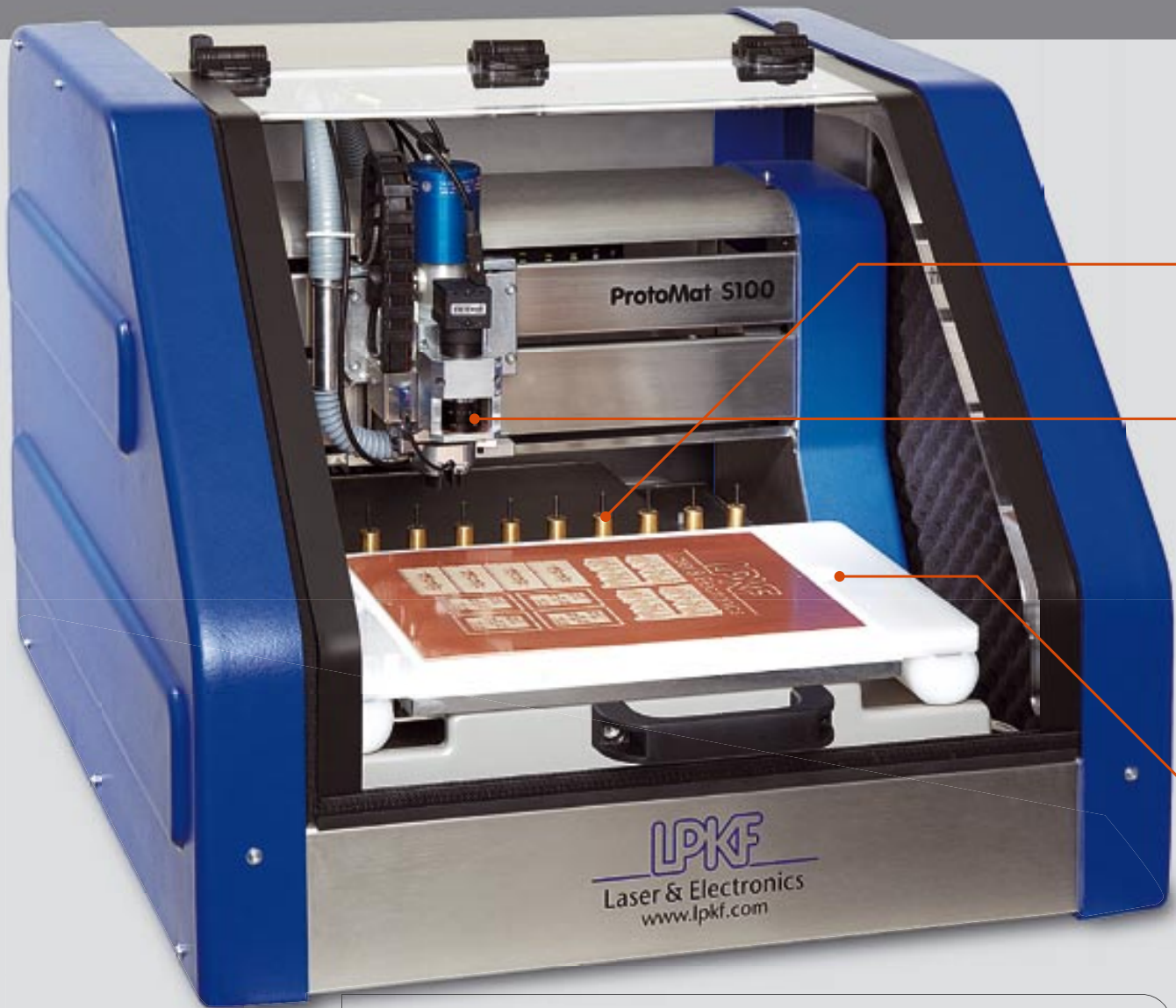

Each LPKF circuit board plotter includes a comprehensive software package for importing data from any PCB CAD package and for controlling the plotter.

CircuitCAM



BoardMaster

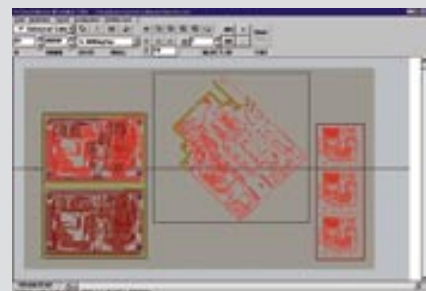

“To me, using the LPKF circuit board plotter is the most useful, time-saving and flexible way to produce my prototypes and individual boards fast and with high precision. Together with a through-hole plating system this is really a most profitable investment.”



Herbert Oppenborn, Manager Electronic Development
Doepke Schaltträger GmbH & Co.KG, Germany

Contents

Top-Features

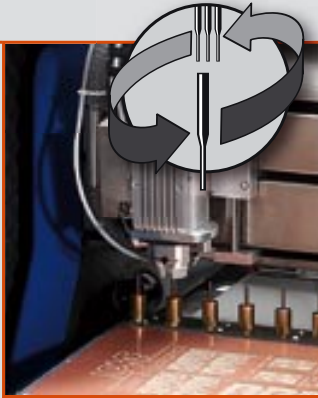

The LPKF **tool changer** automatically replaces milling and drilling tools during board production. This reduces setup time and allows unattended operation.

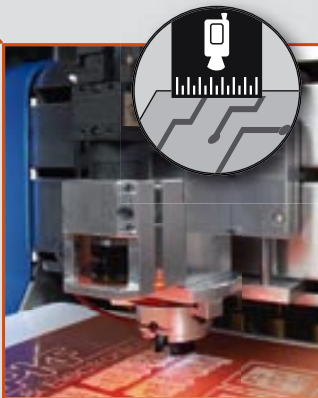

Increase the registration accuracy of most circuit board plotters by adding a **fiducial recognition camera**. The driver software integrates seamlessly with LPKF's software suite and provides automatic recognition and alignment to existing fiducials in the circuit board.

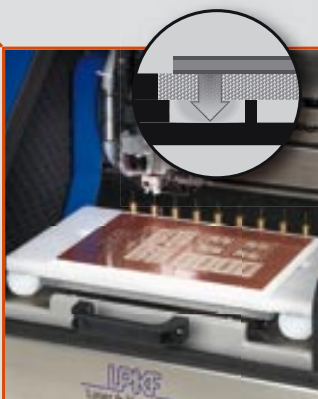

The **vacuum table** option holds the work piece tightly against the work surface, eliminating any substrate irregularities such as twisting or warpage. The tabletop also prevents the board from slipping after it has been flipped for multi-sided milling or drilling.

Introduction to rapid PCB structuring and drilling	6
LPKF ProtoMat S100	7
High-performance for RF and microwave applications	
LPKF ProtoMat S62	11
Advanced PCB prototyping for most applications	
LPKF ProtoMat S42	15
Rapid PCB prototyping in an entry-level package	
LPKF ProtoMat H100	19
High-performance PCB prototyping for all applications	
LPKF ProtoMat M60 and X60	23
Reliable PCB prototyping for large working areas	
Feature comparison	27
Accessories and options	29
Tools	33
Consumables	37
Software	41

Plotters

Laser

Plating

Multilayer

SMT/Finishing

Tech Guide

Index

Introduction to rapid PCB structuring and drilling

LPKF ProtoMat-Series features unmatched precision, flexibility, and ease-of-use. LPKF ProtoMat-Series circuit board plotters play a key role in the rapid in-house production of printed circuit boards, from one-shot engineering projects to production level circuits. LPKF circuit board plotters reduce time-to-market for new designs by keeping fabrication work in-house – no more waiting days or even weeks for a complex prototype to come back from a fabrication house. With an LPKF circuit board plotter, a board can be produced, tested, improved, produced again, and tested several times in a single day. LPKF circuit board plotters are ideal for such applications as high power circuitry, analog circuitry, digital circuitry, RF and microwave circuitry. Warranted and backed by more than three decades of precision German engineering, LPKF ProtoMat circuit board plotters set the standard in printed circuit board milling, drilling, and routing equipment across the world.

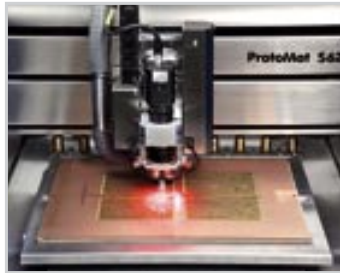

Precision and Speed

All LPKF ProtoMat circuit board plotters feature high-speed spindle motors, ranging from 42,000 rpm to 100,000 rpm. The higher speeds mill and drill the precision geometries required by high frequency and microwave applications. LPKF circuit board plotters produce some of the highest quality and strongest repeatability in the industry, with system resolution as fine as 0.25 μm (0.01 mils). LPKF ProtoMat circuit board plotters are reliable high-speed performers for producing high quality printed circuit boards in-house.

Convenience and Security

LPKF ProtoMat circuit board plotters are universally simple to use. No alignment or calibration steps are necessary. Many LPKF ProtoMat models enjoy automatic tool change and other hands-off features, as well as acoustic cabinets and vacuum systems to reduce sound and environmental impact. ProtoMat circuit board plotters typically connect to a Windows® computer via a standard USB or RS-232 cable. Today's fierce market competition requires absolute security and nothing is more secure than keeping designs inside the prototyping lab. A ProtoMat can be unpacked, set up and fabricating a prototype in less time than a courier could deliver a design to a board house.

Multilayer Boards and Through-Hole Plating

LPKF ProtoMat circuit board plotters are especially well suited for multilayer rapid PCB prototyping. When combined with a multilayer press such as the MultiPress II and a through-hole conductivity solution such as ProConduct®, MiniContac S or Contac III, the ProtoMat circuit board plotters are the initial and key step in producing high quality multilayered printed circuit boards, especially during the critical development phase of any competitive, complex design.

Versatile Software

Every LPKF ProtoMat circuit board plotter ships with a comprehensive software suite, designed to increase productivity and throughput, while allowing for additional flexibility in design. CircuitCAM imports CAD and other image data from a variety of file formats and prepares it for transmission to the ProtoMat. Additionally, CircuitCAM offers unprecedented editing features for data – so modifications can be made closer to the production level. BoardMaster controls the ProtoMat and makes the full capabilities of LPKF's most advanced hardware instantly available in an easy-to-learn WYSIWYG milling, drilling, and routing control application.

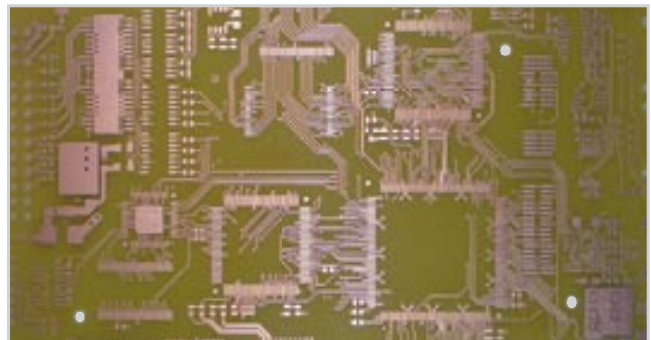

Other Applications

In addition to creating circuit boards in record time, the LPKF ProtoMat machines have proven their versatility time and time again with such varied applications as housing pockets, front panels, metal and plastics machining, depaneling pre-assembled circuit boards, cutting and engraving plastic foils, fabricating precision inspection templates, test adapters, and more.

LPKF ProtoMat S100

High-performance for RF and microwave applications

Item	LPKF ProtoMat S100
Part #	116664
Order info	Inside front cover



Ideal for these applications

- Milling and drilling 1- and 2-sided circuit boards
- RF & microwave circuits
- Multilayer PCBs up to 6 layers
- Contour routing of circuit boards
- Flexible and rigid-flex circuit milling
- Front panels/sign engraving
- Machining cut-outs in front panels
- SMD stencil cutting
- Housing production
- Wave solder pallets
- Depanelization and rework
- Test adapter drilling
- Inspection templates

High travel speed

with max 150 mm/sec (6"/sec)
and resolution of 0.25 μm (0.01 mil).



Plotters

Laser

Plating

Multilayer

SMT/Finishing

Tech Guide

Index

The ProtoMat S100 is one of LPKF's top-of-the-line circuit board plotters, ideal for all in-house prototyping applications, including multilayer and RF applications. The ProtoMat S100 features the highest spindle speed possible – resulting in the precision circuit geometries today's high-frequency and microwave applications demand – and a pneumatic working depth limiter, for the most surface-sensitive substrates. The ProtoMat S100 is an indispensable component of any development group where speed, precision, and simplicity are absolutely required.

- **Ideal for RF and microwave circuitry on all substrates**
- **Superior milling speed, resolution, and accuracy**
- **Automatic tool change for unmatched ease-of-use and unattended operation**
- **Integrated acoustic cabinet for quiet operation**
- **Vacuum table and fiducial recognition available**

The LPKF ProtoMat S100 circuit board plotter features:



Automatic tool change

Advanced features include a 10-position tool changer that automatically replaces milling and drilling tools while the board is being produced. This significantly reduces setup time, and allows for unattended operation.



100,000 rpm spindle motor for precision

The ProtoMat S100 delivers unmatched precision with system resolution as fine as 0.25 μm (0.01 mils). Each system is carefully calibrated at the factory for unsurpassed overall accuracy. As a result, the plotter mills and drills all types of PCBs with extremely fine traces, specializing in the precision trace geometries required by RF and microwave boards. Its milling head travel speed of 150 mm (6") per second and high-performance 100,000 rpm spindle motor make it a premiere high-speed performer.



Non-contact working depth limiter for delicate substrates

The ProtoMat S100 features a fully pneumatic working depth limiter. This allows the S100 to mill, drill, and depanel an entire circuit with nothing but the tools touching the work surface. The pneumatic working depth limiter is recommended for the delicate or surface-sensitive substrates found in many RF applications.



2 1/2-dimensional operation with Z-axis drive

With its unique motorized Z-axis drive, the ProtoMat S100 is ideal for machining instrument front panels and housings, as well as pockets in microwave boards. It can also mill around mounted PCB components, simplifying board rework and depanelization jobs.

And many more, such as:

Convenience and easy handling

The ProtoMat S100's rich featureset and simple, automatic operation are quick and easy to master. Board production begins within minutes of switching on the machine. A standard USB or RS-232 cable connects the ProtoMat S100 to any Windows-compatible computer.

Integrated head lighting

Shadow-free illumination of the milling area from integrated head lighting makes direct quality control faster and easier.

Acoustic cabinet

An integrated acoustic cabinet reduces system sounds and acts as a protective cover. The circuit board plotter can safely operate in any work environment.

CAM software included

Each plotter comes with comprehensive LPKF CircuitCAM and BoardMaster software for importing PCB data from any CAD package and for controlling the operation of the circuit board plotter. This easy-to-use software, developed by LPKF, processes the same data that would be sent to a PCB manufacturer.



The ProtoMat S100 ships with a Multimedia Training CD!



Applications

The LPKF ProtoMat S100 is ideal for the following applications:

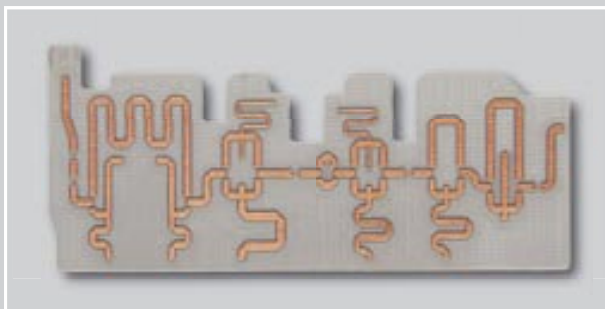

RF and microwave circuits

The ProtoMat S100 is ideal for reproducing the precision geometry required by RF and microwave prototyping. Custom-designed carbide tools create straight sidewalls and reduce penetration into the substrate by the tool.

High quality printed circuit boards

The ProtoMat S100 is also useful for producing high quality professional printed circuit boards from two- to six-layer prototypes.

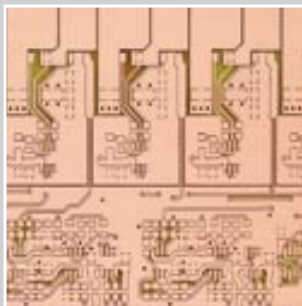

Housings

In addition to flat circuit boards and signs, LPKF ProtoMat circuit board plotters are useful in a prototyping laboratory when routing out and machining three-dimensional objects, such as housings and pockets in such material as aluminum or plastic.



Additional application for the ProtoMat S100:

	Application Notes
Milling and drilling 1- & 2-sided circuit boards	✓
RF and microwave circuits	✓
Multilayer PCBs up to 6 layers	✓ LPKF recommends the optional Fiducial Recognition Camera.
Contour routing of circuit boards	✓
Flexible and rigid-flex circuit milling	✓ This application requires the optional vacuum table.
Front panels/sign engraving	✓
Machining cut-outs in front panels	✓
SMD stencil cutting	✓
Housing production	✓
Wave solder pallets	✓
Depanelization and rework	✓
Test adapter drilling	✓
Inspection templates	✓

Options

More information on options on page 29.

Fiducial recognition camera

Use the fiducial recognition camera to align a board for double or multilayer production quickly and accurately. Requires USB 2.0.



Vacuum tabletop

The vacuum tabletop holds the work piece tightly against the work surface, eliminating any substrate irregularities such as twisting or warpage.



Accessories, software, tools and consumables



Accessories

More details on page

Dust extraction	31
Keeps the work area free of debris of all sizes.	
Compressor	32
A clean source of compressed air.	
Measuring microscope	31
60x magnification for proper alignment.	
StatusLight	32
Indicates the status of the machine.	
Brush head	31
Removes debris from the work area when working in 2 1/2-dimensional mode.	



Software (included)

More details on page

LPKF CircuitCAM PCB	42
A complete workstation for the ProtoMat S100.	
LPKF BoardMaster	43
Versatile control software for all ProtoMat models.	



Tools

More details on page

Conical milling tools	34
Sturdy tooling for all purposes.	
Cylindrical milling tools	34
Ideal for RF structuring.	
Drilling/routing tools	35
Drilling and depaneling bits.	



Consumables

More details on page

Starter Set	38
Contains high-quality tools and consumable material.	
Multilayer Start-Set	39
Everything needed to start making multilayer boards.	
Base materials	40
A collection of copper clad FR4 substrates.	

Specification table

LPKF ProtoMat S100	
Part #	116664
Working area (X/Y/Z)	229 x 305 x 38 mm (9" x 12" x 1.5")
Resolution (X/Y)	0.25 µm (0.01 mil)
Repeatability	±0.001 mm (±0.04 mil)
Precision of front-to-back alignment	±0.02 mm (±0.8 mil)
Milling motor	Max. 100,000 rpm, software controlled
Tool change	Automatic, 10 positions
Tool collet	3.175 mm (1/8"), pneumatic release collet
Drilling speed	150 strokes/min
Travel speed (max)	Max. 150 mm/sec (6"/sec)
X/Y positioning system	3-phase stepper motors
Z drive	Stepper motor
Dimensions (W/H/D)	670 x 540 x 760 mm (26.4" x 21.3" x 29.9")
Weight	55 kg (121 lb)
Power supply	115/230 V, 50–60 Hz, 200 W
Compressed air supply	6 bar (87 psi), 100 l/min (3.528 cfm)
Specifications subject to change.	

Size of tracks and gaps depends on materials and tools. 100 µm tracks and gaps possible with LPKF MicroCutter on FR4 18/18 µm Cu. More information on materials page 89 and tools page 33.

LPKF ProtoMat S62

Advanced PCB prototyping for most applications

Item	LPKF ProtoMat S62
Part #	115788
Order info	Inside front cover



Ideal for these applications

- Milling and drilling 1- and 2-sided circuit boards
- Multilayer PCBs up to 6 layers
- Contour routing of circuit boards
- Front panels/sign engraving
- Machining cut-outs in front panels
- SMD stencil cutting
- Housing production
- Depanelization and rework
- Test adapter drilling
- Inspection templates

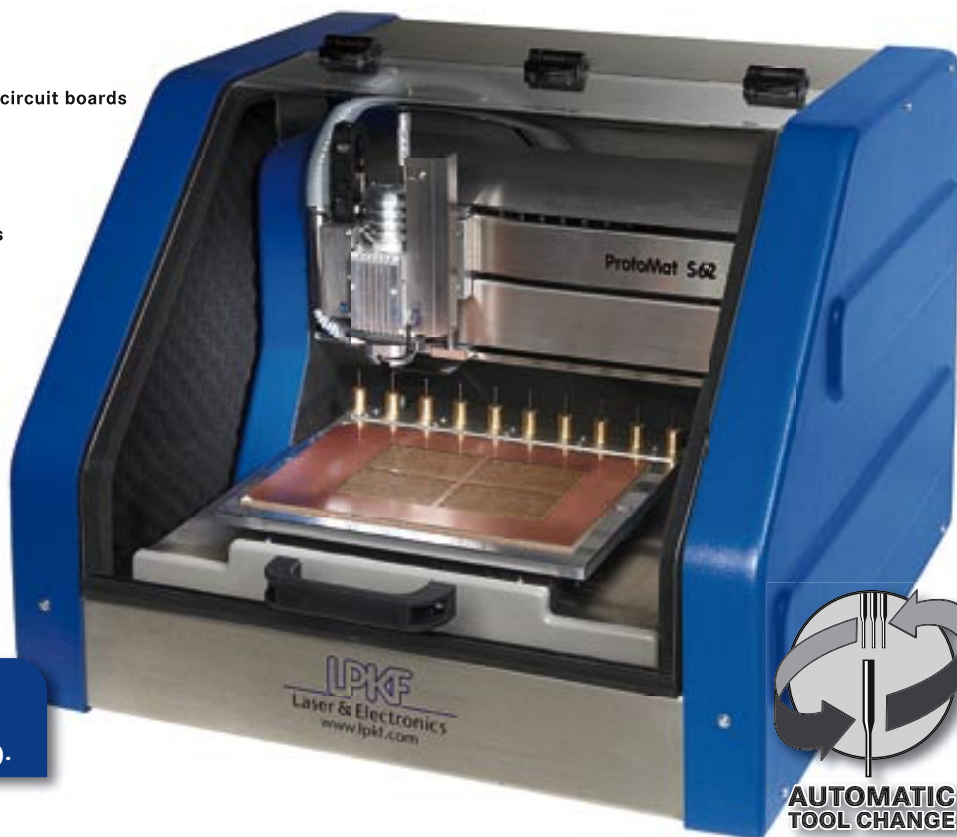

High travel speed
with max 150 mm/sec (6"/sec)
and resolution of 0.25 µm (0.01 mil).

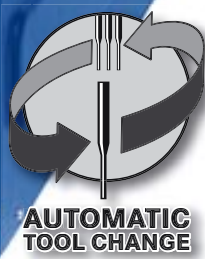

The ProtoMat S62 is a state-of-the-art circuit board plotter, ideal for most in-house prototyping applications where speed and security are essential, including multilayer and RF applications. The S62 features a high speed spindle motor, ideal for many applications requiring more precise circuit geometry, as well as a host of other features that make it an ideal addition to any development environment.

This compact high-speed circuit board plotter provides unequalled precision and performance for quickly and easily milling and drilling circuit board prototypes in a single day. Production delays and the high cost of outside vendors can be eliminated, reducing a product's development time and time-to-market dramatically. Design data also remains securely in-house and under control.

- **Excellent milling speed, resolution, and accuracy**
- **Automatic tool change for unmatched ease-of-use**
- **Integrated acoustic cabinet for quiet operation**
- **Vacuum table and fiducial recognition available**



E&E Best Product Guide 2005
The LPKF ProtoMat S62 has been awarded the best new development in the area of production and automation by the readership of E&E in 2005.

- Plotters
- Laser
- Plating
- Multilayer
- SMT/Finishing
- Tech Guide
- Index

The LPKF ProtoMat S62 circuit board plotter features:

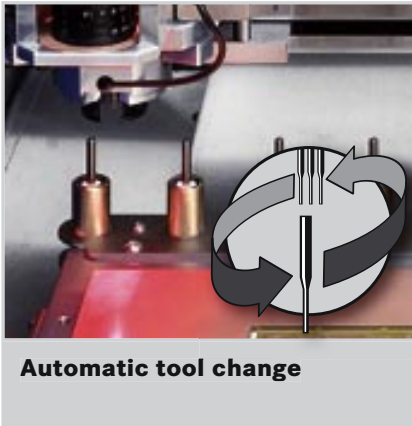

Automatic tool change

Advanced features include a 10-position tool changer that automatically replaces milling and drilling tools while the board is being produced. This significantly reduces setup time, and allows for unattended operation.



62,000 rpm spindle motor for precision and speed

The ProtoMat S62 delivers unmatched precision with system resolution as fine as 0.25 μm (0.01 mils). Each system is carefully calibrated at the factory for unsurpassed overall accuracy. As a result, the circuit board plotter can mill and drill all types of PCBs with extremely fine traces, including most RF and microwave boards. Its milling head travel speed of 150 mm (6") per second and high-performance 62,000 rpm spindle motor makes it a premiere high-speed performer for producing quality PCBs in-house.



2 1/2-dimensional operation with Z-axis drive

With its unique motorized Z-axis drive, the ProtoMat S62 is ideal for machining instrument front panels and housings. It can also mill around mounted PCB components, simplifying board rework and depanelization jobs.

And many more, such as:

Convenience and easy handling

The ProtoMat S62's rich featureset and simple, automatic operation are quick and easy to master. Board production begins within minutes of switching on the machine, and requires no external air compressors. A standard USB or RS-232 cable connects the ProtoMat S62 to any compatible Windows® computer.

Acoustic cabinet

An integrated acoustic cabinet reduces system sounds and acts as a protective cover. The circuit board plotter can safely operate in any work environment.

Integrated head lighting for illumination of milling area

Shadow-free illumination of the milling area from integrated head lighting makes direct quality control faster and easier.

CAM software included

Each circuit board plotter comes with comprehensive LPKF CircuitCAM and BoardMaster software for importing PCB data from any CAD package and for controlling the operation of the circuit board plotter. This easy-to-use software, developed by LPKF, processes the same data that would be sent to a PCB manufacturer.



The ProtoMat S62 ships with a Multimedia Training CD!



Applications

Although the LPKF ProtoMat S62 is an excellent tool for a wide variety of applications, it is particularly well-suited for:

Multilayer circuit boards

The ProtoMat S62 is a key component to any application requiring multilayer circuit boards. Fabricate multilayer prototypes using the S62 circuit board plotter with a through-hole conductivity system such as the MiniContac S and a board press such as the MultiPress II.

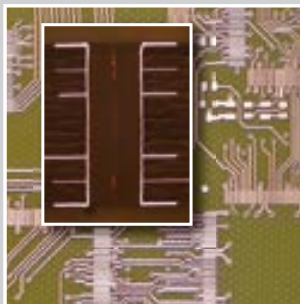

Front panels and sign production

The S62 engraves and routes front panels and signs with extraordinary precision, on such varied surfaces as plastics, Plexiglas®, aluminum, brass, and more.

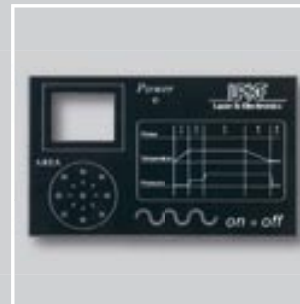

Housings

In addition to flat circuit boards and signs, the S62 is even more useful in a prototyping laboratory when used to rout out and machine dimensional objects, such as housings and pockets in material.



Routing slots, cut outs and board profiles

Even with complex shapes, the S62 easily routes out circuit board contours, or depanelizes populated boards from existing frames.



Additional applications for the LPKF ProtoMat S62:

	Application Notes
Milling and drilling 1- & 2-sided circuit boards	✓
RF and microwave circuits	✓
Multilayer PCBs up to 6 layers	✓ LPKF recommends the optional Fiducial Recognition Camera.
Contour routing of circuit boards	✓
Flexible and rigid-flex circuit milling	✓ This application requires the optional vacuum table.
Front panels/sign engraving	✓
Machining cut-outs in front panels	✓
SMD stencil cutting	✓
Housing production	✓
Wave solder pallets	✓
Depanelization and rework	✓
Test adapter drilling	✓
Inspection templates	✓

Options

More information on options on page 29.

Fiducial recognition camera

Use the fiducial recognition camera to align a board for double or multilayer production quickly and accurately. Requires USB 2.0.



Vacuum tabletop

The vacuum tabletop holds the work piece tightly against the work surface, eliminating substrate irregularities.



Accessories, software, tools and consumables



Accessories

More details on page

Dust extraction	31
Keeps the work area free of debris of all sizes.	
Measuring microscope	31
60x magnification for proper alignment.	
StatusLight	32
Indicates the status of the machine.	
Brush head	31
Removes debris from the work area when working in 2 1/2-dimensional mode.	



Software (included)

More details on page

LPKF CircuitCAM PCB	42
A complete workstation for the ProtoMat S62.	
LPKF BoardMaster	43
Versatile control software for all ProtoMat models.	



Tools

More details on page

Conical milling tools	34
Sturdy tooling for all purposes.	
Cylindrical milling tools	34
Ideal for RF structuring and big rubouts.	
Drilling/routing tools	35
Drilling and depaneling bits.	



Consumables

More details on page

Starter Set	38
Contains high-quality tools and consumable material.	
Multilayer Start-Set	39
Everything needed to start making multilayer boards.	
Base materials	40
A collection of copper clad FR4 substrates.	

Specification table

LPKF ProtoMat S62	
Part #	115788
Working area (X/Y/Z)	229 x 305 x 38 mm (9" x 12" x 1.5")
Resolution (X/Y)	0.25 µm (0.01 mil)
Repeatability	±0.001 mm (±0.04 mil)
Precision of front-to-back alignment	±0.02 mm (±0.8 mil)
Milling motor	Max. 62,000 rpm, software controlled
Tool change	Automatic, 10 positions
Tool collet	3.175 mm (1/8")
Drilling speed	150 strokes/minute
Travel speed (max)	Max. 150 mm/second (6"/second)
X/Y positioning system	3-phase stepper motors
Z drive	Stepper motor
Dimensions (W/H/D)	670 x 540 x 760 mm (26.4" x 21.3" x 29.9")
Weight	55 kg (121 lb)
Power supply	115/230 V, 50–60 Hz, 200 W
Compressed air supply	Not required

Specifications subject to change.

Size of tracks and gaps depends on materials and tools. 100 µm tracks and gaps possible with LPKF MicroCutter on FR4 18/18 µm Cu. More information on materials page 89 and tools page 33.



LPKF ProtoMat S42

Rapid PCB prototyping in an entry-level package

Item	LPKF ProtoMat S42
Part #	117468
Order info	Inside front cover



Ideal for these applications

-  Milling and drilling 1- and 2-sided circuit boards
-  Front panels/sign engraving
-  SMD stencil cutting



Plotters

Laser

Plating

Multilayer

SMT/Finishing

Tech Guide

Index

The LPKF ProtoMat S42 introduces a new entry-level circuit board plotter for in-house rapid PCB prototyping. This compact system provides precision and performance for quickly and easily milling and drilling circuit board prototypes in a single day. In-house PCB prototyping eliminates production delays and the high cost of outside vendors, reducing a product's development time and time-to-market dramatically. Design data also remains securely in-house and under control. The S42 in particular is a perfect entry-level tool for educational and other settings where economy is a critical issue.

- **Entry level system for precision prototypes**
- **Easy operation with quick-release tool change**
- **Vacuum table, fiducial recognition and acoustic cabinet available**

The LPKF ProtoMat S42 circuit board plotter features:



42,000 rpm high-performance spindle motor

Each ProtoMat S42 is carefully calibrated at the factory for unsurpassed overall accuracy. As a result, the circuit board plotter can mill and drill all types of PCBs with fine traces, using reliable, well-tested technology. Its milling head travel speed of 50 mm (approx. 2”) per second and high-performance 42,000 rpm spindle motor makes it an excellent entry-level performer for producing quality PCBs in-house.



Integrated head lighting for illumination of milling area

Shadow-free illumination of the milling area from integrated head lighting makes direct quality control faster and easier.

And many more, such as:

Convenience and easy handling

The ProtoMat S42’s simple operation is quick and easy to master. Board production begins within minutes of switching on the machine, and it requires no external air compressors or other products. A standard USB or RS-232 cable connects the ProtoMat S42 to any compatible Windows® computer.

CAM software included

Each ProtoMat S42 includes LPKF CircuitCAM Lite and BoardMaster software for importing PCB data from any CAD package and for controlling the operation of the circuit board plotter. This easy-to-use software, developed by LPKF, processes the same data sent to PCB manufacturers.



Ideal for colleges and technical schools

The LPKF ProtoMat S42 is an excellent tool for colleges and technical institutions, allowing students and instructors to immediately produce printed circuit boards that are production quality and chemical free, right in the classroom environment. Low consumable costs, instant turnaround, and no need for external vendors encourages more practical exercises and experiments in the classroom or laboratory.

“Things are going great with our LPKF machine – we have prototyped four different boards (two of which went off for volume production – using the prototype boards we found an error on each of these designs – very nice). For one of the other designs we made 10 small boards in house. We also need to make six more unique boards this semester as part of our Microprocessor course. I love this thing.

Thanks – again, we are loving the product. Seems like it is costing us about \$5-\$10 per board. This is reasonable enough – especially considering the pedagogical value and the freedom to make mistakes.



Gary Spivey, Ph.D.
 Assistant Professor of Electrical Engineering
 Department of Mathematics, Computer Science, and Engineering
 George Fox University, USA



Applications

Although the LPKF ProtoMat S42 is an excellent tool for a wide variety of applications, it is particularly well-suited for:

1- and 2-sided circuit boards on different materials

The most common use for the LPKF ProtoMat S42 is the production of high-quality professional printed circuit boards on FR4 in a prototyping environment. This system reproduces a prototype accurately from the original design data.

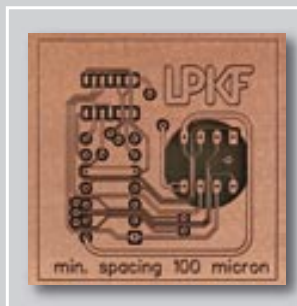

Additional applications for the LPKF ProtoMat S42:

		Application Notes
	Milling and drilling 1- & 2-sided circuit boards	✓
	RF and microwave circuits	-
	Multilayer PCBs up to 6 layers	✓ LPKF recommends the S100, S62 or H100 for multilayer boards.
	Contour routing of circuit boards	✓ LPKF recommends the use of the S100, S62, H100, M60 or X60.
	Flexible and rigid-flex circuit milling	-
	Front panels/sign engraving	✓ LPKF recommends the use of the S100, S62, H100, M60 or X60.
	Machining cut-outs in front panels	-
	SMD stencil cutting	✓ LPKF recommends the use of the S100, S62, H100, M60 or X60.
	Housing production	-
	Wave solder pallets	-
	Depanelization and rework	-
	Test adapter drilling	-
	Inspection templates	-

Options

More information on options on page 29.

Acoustic cabinet

LPKF acoustic cabinets reduce noise and dust emissions, perfect for CAD offices and electronics prototyping labs.

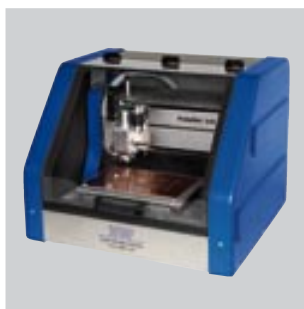

Fiducial recognition camera

Front-to-back and multilayer alignment is automated by locating fiducials. The PCB can be remounted or flipped and it will always be properly aligned.



Vacuum tabletop

Use the fiducial recognition camera to align a board for double or multilayer production quickly and accurately. Requires USB 2.0.



Accessories, software, tools and consumables



Accessories

More details on page

Dust extraction	31
Keeps the work area free of debris of all sizes.	
Measuring microscope	31
60x magnification for proper alignment.	



Software (included)

More details on page

LPKF CircuitCAM Lite	42
CAM workstation specially for the S42.	
LPKF BoardMaster	43
Versatile control software for all ProtoMat models.	



Tools

More details on page

Conical milling tools	34
Sturdy tooling for all purposes.	
Cylindrical milling tools	34
Ideal for big rubouts.	
Drilling/routing tools	35
Drilling and depaneling bits.	



Consumables

More details on page

Starter Set	38
Contains high-quality tools and consumable material.	
Multilayer Start-Set	39
Everything needed to start making multilayer boards.	
Base materials	40
A collection of copper clad FR4 substrates.	

Specification table

LPKF ProtoMat S42	
Part #	117468
Working area (X/Y)	229 x 305 mm (9" x 12")
Resolution (X/Y)	7.5 µm (0.3 mil)
Repeatability	±0.005 mm (±0.2 mil)
Precision of front-to-back alignment	±0.02 mm (±0.8 mil)
Milling motor	Max. 42,000 rpm, software controlled
Tool change	Manual
Tool collet	3.175 mm (1/8")
Drilling speed	90 strokes/min
Travel speed (max.)	Max. 50 mm/sec (1.97"/sec)
X/Y positioning system	2-phase stepper motors
Z drive	Solenoid (5 mm stroke)
Dimensions (W/H/D)	580 x 480 x 620 mm (22.8" x 18.9" x 24.4")
Weight	43 kg (94.8 lb)
Power supply	115/230 V, 50–60 Hz, 200 W
Compressed air supply	Not required

Specifications subject to change.

Size of tracks and gaps depends on materials and tools. 100 µm tracks and gaps possible with LPKF MicroCutter on FR4 18/18 µm Cu. More information on materials page 89 and tools page 33.









LPKF ProtoMat H100

High-performance PCB prototyping for all applications

Item	LPKF ProtoMat H100
Part #	111424
Order info	Inside front cover



Ideal for these applications

-  Milling and drilling 1- and 2-sided circuit boards
-  RF and microwave substrates
-  Multilayer PCBs up to 6 layers
-  Contour routing of circuit boards
-  Flexible and rigid-flex circuit milling
-  Front panels/sign engraving
-  Machining cut-outs in front panels
-  SMD stencil cutting
-  Inspection templates

Ideal for large substrates.

420 mm (16.5")

380 mm
(15")

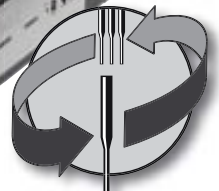
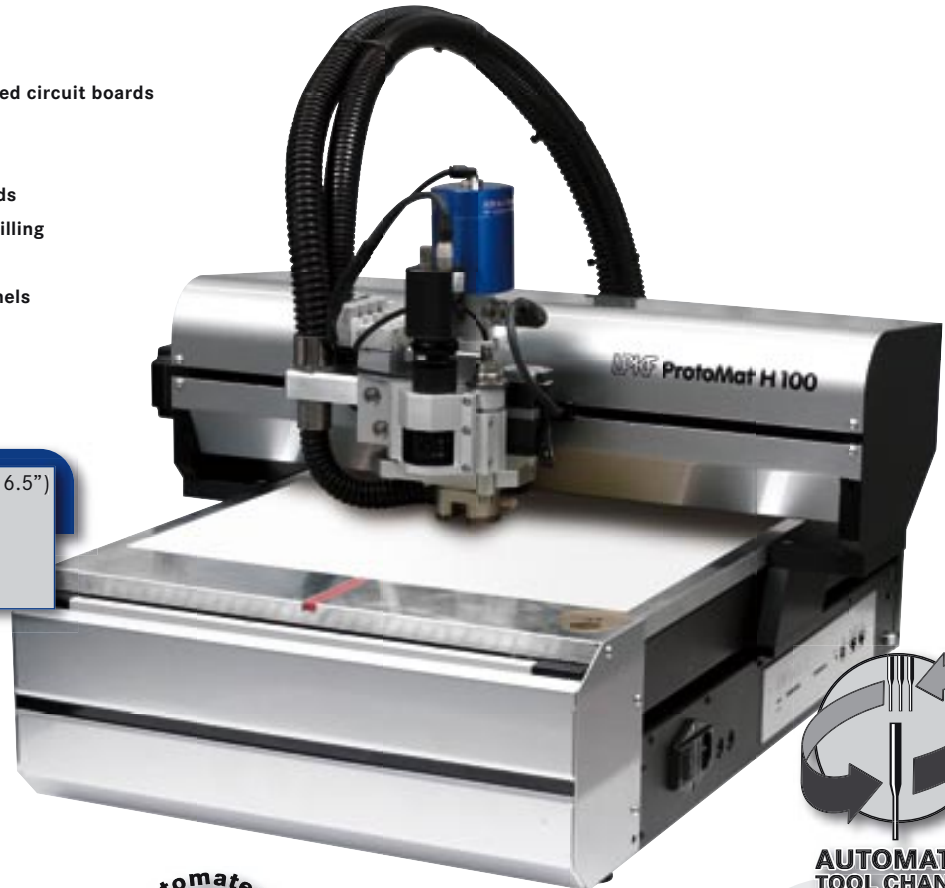

**AUTOMATIC
TOOL CHANGE**



The ProtoMat H100 is LPKF's top-of-the-line circuit board plotter, ideal for all in-house prototyping applications, including multilayer and RF applications. The fully automated ProtoMat H100 features the highest spindle speed possible – resulting in the precision circuit geometries today's high-frequency and microwave applications demand – and a pneumatic working depth limiter, for surface-sensitive substrates. The ProtoMat H100 is specially designed to handle larger working surfaces, 380 mm x 420 mm (15" x 16.5"). The ProtoMat H100 is an indispensable component of any development group where speed, precision, and simplicity are absolutely required.

- **Ideal for all applications**
- **Greatest speed, accuracy and resolution**
- **Automatic tool change**
- **Fully automated machine**
- **Integrated fiducial recognition camera**
- **Automated depth sensor**
- **Integrated vacuum table top**

Plotters

Laser

Plating

Multilayer

SMT/Finishing

Tech Guide

Index

The LPKF ProtoMat H100 circuit board plotter features:

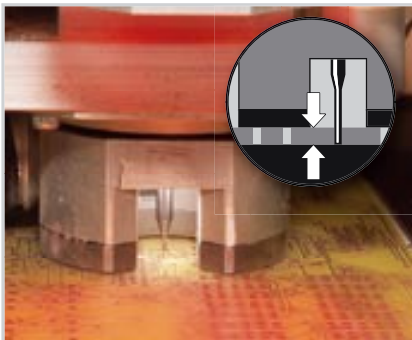

Automatic depth control sensing

The ProtoMat H100 automatically senses the work surface as it operates, precisely automating a task that normally requires careful manual operation.

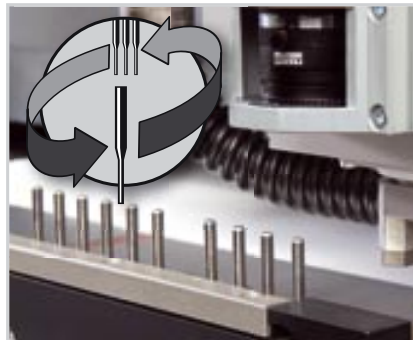

Fully automatic tool change

Advanced features include a 30-position tool changer that automatically replaces milling and drilling tools while the board is being produced. This reduces setup time, and allows for unattended operation.

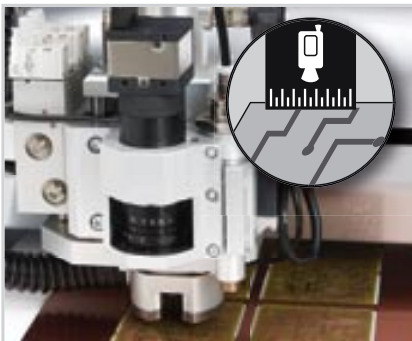

Fiducial recognition camera

The ProtoMat H100 includes a fiducial recognition camera, increasing accuracy and making it ideal for multilayer applications.

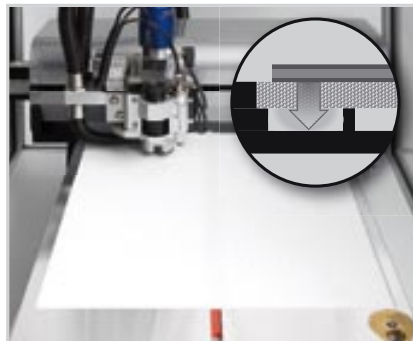

Vacuum tabletop

Holds the workpiece tightly against the work surface and eliminates substrate irregularities, such as twisting or warpage.

Fully equipped

No options necessary. The ProtoMat H100 is fully equipped. (The dust extraction unit can be placed behind the acoustic cabinet.)



And many more, such as:

Non-contact working depth limiter

The ProtoMat H100 features a pneumatic working depth limiter. This allows the H100 to mill, drill, and depanel an entire circuit with nothing but the tools touching the work surface.

100,000 rpm spindle motor

The ProtoMat H100's milling head travel speed of 150 mm (6") per second and high-performance 100,000 rpm spindle motor makes it a premiere high-speed performer for producing quality printed circuit boards.

Workstation cabinet

The H100 includes an acoustic cabinet. This reduces system sounds and acts as a protective cover. The plotter operates safely in any work environment.

Integrated head lighting

Shadow-free illumination of the milling area from integrated head lighting makes direct quality control faster and easier.

Dust extraction

The LPKF dust extraction system, complete with a HEPA absolute filter, is especially well-suited for keeping the work area clean and free of debris of all sizes, from drill shavings to microscopic dust.

CAM software included

Each circuit board plotter comes with comprehensive LPKF CircuitCAM and BoardMaster software for importing PCB data from any CAD package and for controlling the operation of the circuit board plotter. This software, developed by LPKF, processes the same data that would be sent to a PCB manufacturer.



Applications

The LPKF ProtoMat H100 is ideal for the following applications:

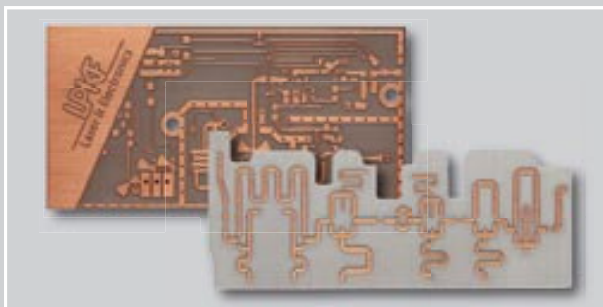

RF and microwave circuits

RF and microwave prototyping requires a variety of special substrates, including PTFE based and ceramic filled (RO4000®) substrates, and extremely precise trace geometries. The H100 produces exactly this kind of precise cut, with unmatched accuracy.

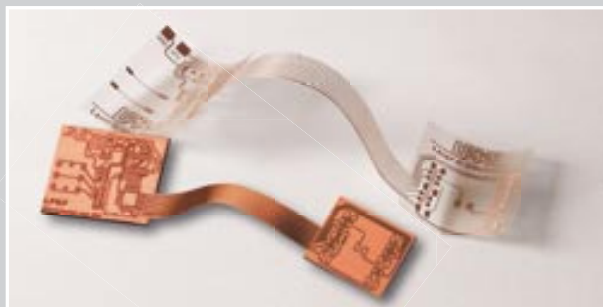

Flexible and rigid-flex circuit boards

With its non-contact working depth limiter and integrated vacuum tabletop, the H100 easily processes a wide range of flexible circuit material. LPKF circuit board plotters consistently excel at producing rigid-flex circuit boards. In small batch production as well as prototyping, circuit board plotters with non-contact working depth limiters produce the best results in these technologically challenging situations.

Ultra-fine printed circuit boards

The most common application is the production of high quality professional printed circuit boards in a prototyping environment.

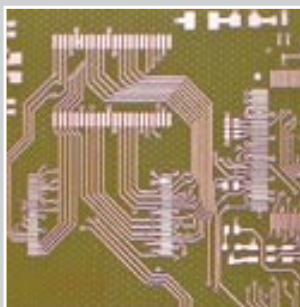

Multilayer PCBs up to 6 layers

Fabricate six-layer prototypes using a ProtoMat H100, a press such as the MultiPress II and a through-hole conductivity solution such as the Contac III.

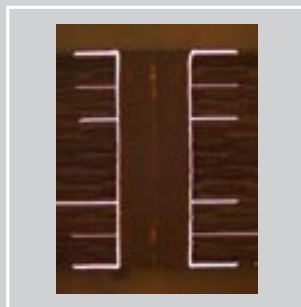

Additional applications for the ProtoMat H100:

	Application Notes
Milling and drilling 1- & 2-sided circuit boards	✓
RF and microwave circuits	✓
Multilayer PCBs up to 6 layers	✓
Contour routing of circuit boards	✓
Flexible and rigid-flex circuit milling	✓
Front panels/sign engraving	✓
Machining cut-outs in front panels	✓
SMD stencil cutting	✓
Housing production	-
Wave solder pallets	-
Depanelization and rework	✓ For depaneling of populated boards, LPKF recommends the S100 or S62.
Test adapter drilling	-
Inspection templates	✓

Options

More information on options on page 29.

No options necessary: Fully equipped!

For detailed information on options and accessories, please see page 29.

Accessories, software, tools and consumables



Accessories

	More details on page
Compressor	32
A clean source of compressed air.	
Measuring microscope	31
60x magnification for proper alignment.	
StatusLight	32
Indicates the status of the machine.	



Software (included)

	More details on page
LPKF CircuitCAM PCB	42
A complete workstation for the ProtoMat H100.	
LPKF BoardMaster	43
Versatile control software for all ProtoMat models.	



Tools

	More details on page
Conical milling tools	34
Sturdy tooling for all purposes	
Cylindrical milling tools	34
Ideal for RF structuring.	
Drilling/routing tools	35
Drilling and depaneling bits.	



Consumables

	More details on page
Starter Set	38
Contains high-quality tools and consumable material.	
Multilayer Start-Set	39
Everything needed to start making multilayer boards.	
Base materials	40
A collection of copper clad FR4 substrates.	

Specification table

LPKF ProtoMat H100	
Part #	111424
Working area (X/Y)	420 x 380 mm (16.5" x 15")
Resolution (X/Y)	0.25 µm (0.01 mil)
Repeatability	±0.001 mm (±0.04 mil)
Precision of front-to-back alignment	±0.02 mm (±0.8 mil)
Milling motor	Max. 100,000 rpm, software controlled
Tool change	Automatic, 30 tools
Tool collet	3.175 mm (1/8"), pneumatic release collet
Drilling speed	120 strokes/min
Travel speed	Max. 150 mm/sec (6"/sec)
X/Y positioning system	3-phase stepper motors
Z drive	Pneumatic (14 mm/0.55")
Dimensions (W/H/D)	650 x 430 x 750 mm (25.6" x 17" x 29.5")
Weight	50 kg (110 lb)
Power supply	115/230 V, 50–60 Hz, 200 W
Compressed air supply	6 bar (87 psi), 100 l/min (3.528 cfm)
Specifications subject to change.	

Size of tracks and gaps depends on materials and tools. 100 µm tracks and gaps possible with LPKF MicroCutter on FR4 18/18 µm Cu. More information on materials page 89 and tools page 33.

LPKF ProtoMat M60 and X60

Reliable PCB prototyping for large working areas

Item	LPKF ProtoMat M60/X60
Part #	M60: 108002, X60: 109643
Order info	Inside front cover



Ideal for these applications

- Milling and drilling 1- and 2-sided circuit boards
- Multilayer PCBs up to 6 layers
- Contour routing of circuit boards
- Front panels/sign engraving
- Machining cut-outs in front panels
- SMD stencil cutting
- Depanelization
- Inspection templates



Ideal for large substrates.
540 mm (21.25")
375 mm (14.755")

Ideal for large substrates.
650 mm (25.6")
530 mm (20.8")

The LPKF ProtoMat M60 and ProtoMat X60 combine rapid PCB prototyping with reliable, robust technology in a package designed for large-scale substrates and applications.

The LPKF ProtoMat M60 and the LPKF ProtoMat X60 are specially designed circuit board plotters, ideal for most in-house prototyping applications where speed and security are essential, including multilayer and RF applications. These circuit board plotters feature particularly large working areas, perfect for antennas, sensors, sign engraving, depaneling, and large circuit board substrates.

- **Large working areas**
- **Fiducial recognition available**
- **Reliable, robust technology**

Plotters

Laser

Plating

Multilayer

SMT/Finishing

Tech Guide

Index



The LPKF ProtoMat M60 and X60 circuit board plotters feature:

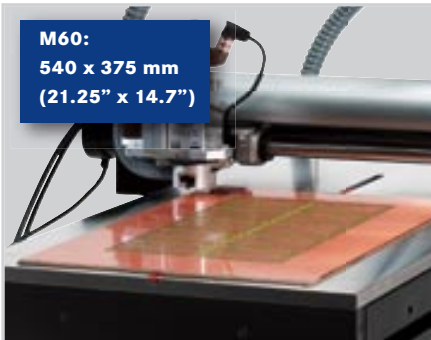

Large working areas

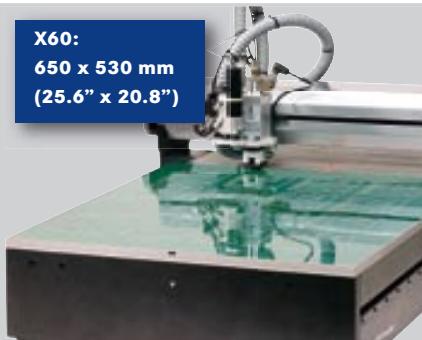

The X60 features 70% more working area than the M60.

The ProtoMat M60 features a work area of 540 x 375 mm (21.25" x 14.7"), making it ideal for larger substrates than most circuit board plotters can handle.

The ProtoMat X60 offers an even larger work area of 650 x 530 mm (25.6" x 20.8"), ideal for large circuits, antennas, and depaneling operations, as well as engraving on plastics and soft metals. The engraving and routing of 19" frontpanels is easily done with the ProtoMat X60.

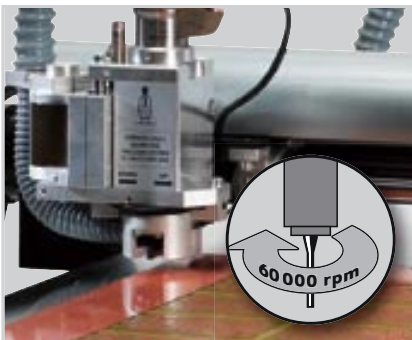

60,000 rpm spindle motor for precision and speed

The ProtoMat M60 and X60 deliver excellent precision with system resolution as fine as 1 µm (0.04 mils) for the ProtoMat X60 and 7.5 µm (0.3 mil) for the ProtoMat M60. Both circuit board plotters can mill and drill all types of PCBs with fine traces, including RF and microwave boards. The high-performance 60,000 rpm spindle motors make these ProtoMat circuit board plotters premiere high-speed performers for producing large-scale, high-quality PCBs in-house.

And many more, such as:

Convenience and easy handling

The ProtoMat M60 and X60's rich featureset and simple operation are quick and easy to master. Board production can begin within minutes of switching on the machine. A standard USB or RS-232 cable connects the circuit board plotters to any compatible Windows® computer.

CAM software included

Each circuit board plotter ships with comprehensive LPKF CircuitCAM and BoardMaster software for importing PCB data from any CAD package and for controlling the operation of the circuit board plotter. This easy-to-use software, developed by LPKF, processes the same data that would be sent to a PCB manufacturer.

Non-contact working depth limiter

The ProtoMat X60 features a pneumatic working depth limiter. This allows the X60 to mill, drill and depanel an entire circuit with nothing but the tools touching the work surface. The pneumatic working depth limiter is recommended for delicate and surface-sensitive substrates.

Brush head

The ProtoMat X60 is equipped with a brush head, used during rework procedures to help protect placed components, while maintaining a sufficient low-pressure region for the vacuum system to remove debris from the work area.



Applications

The LPKF ProtoMat M60 and X60 are ideal for the following applications:



Front panels and sign engraving

The ProtoMat M60 and X60 are ideal tools for engraving and routing of 19" front panels and signs on various materials such as plastic, aluminum, brass and more.

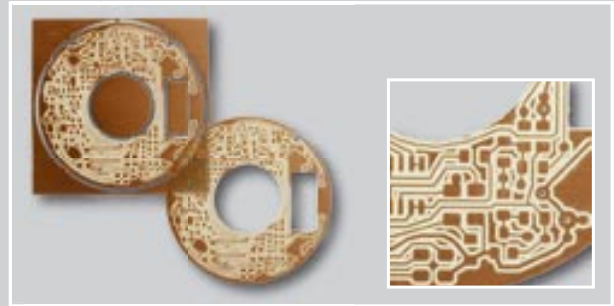

Routing slots, cut-outs and board profile

Even with complex shapes, the M60 and X60 easily rout out circuit board contours. Slots, cut-outs, and other features are also simple to program and cut.

Depaneling

The ProtoMat X60 is a cost-effective addition to congested production lines particularly for the depaneling of unpopulated boards.

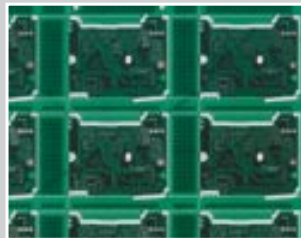

Further applications for the LPKF ProtoMat M60 and X60 are:

		Application Notes
	Milling and drilling 1- & 2-sided circuit boards	✓
	RF and microwave circuits	✓ LPKF recommends the S100 or H100 for RF/microwave work.
	Multilayer PCBs up to 6 layers	✓ Fiducial recognition camera recommended for this application..
	Contour routing of circuit boards	✓
	Flexible and rigid-flex circuit milling	✓ LPKF recommends the use of the H100, S100, or S62.
	Front panels/sign engraving	✓
	Machining cut-outs in front panels	✓
	SMD stencil cutting	✓
	Housing production	-
	Wave solder pallets	-
	Depanelization and rework	✓ Only for depaneling unpopulated PCBs.
	Test adapter drilling	-
	Inspection templates	✓

Options

More information on options on page 29.

Fiducial recognition camera

Front-to-back and multilayer alignment is automated by locating fiducials. The PCB can be remounted or flipped and it will always be properly aligned.



Acoustic cabinet

A specially designed LPKF acoustic cabinet for the ProtoMat M60 reduces noise and dust emission, perfect for CAD offices and electronics prototyping labs.



Accessories, software, tools and consumables



Accessories

	More details on page
Compressor	32
A clean source of compressed air.	
Dust extraction	31
For keeping the work area clean and free of debris.	
Measuring microscope	31
60x magnification for proper alignment.	
StatusLight (ProtoMat M60)	32
Indicates the status of the machine.	



Software (included)

	More details on page
LPKF CircuitCAM PCB	42
A complete workstation for the ProtoMat M60.	
LPKF BoardMaster	43
Versatile control software for all ProtoMat models.	



Tools

	More details on page
Conical milling tools	34
Sturdy tooling for all purposes	
Cylindrical milling tools	34
Ideal for big rubouts.	
Drilling/routing tools	35
Drilling and depaneling bits.	



Consumables

	More details on page
Starter Set	38
Contains high-quality tools and consumable material.	
Multilayer Start-Set	39
Everything needed to start making multilayer boards.	
Base materials	40
A collection of copper clad FR4 substrates.	

Specification table

	LPKF ProtoMat M60	LPKF ProtoMat X60
Part #	108002	109643
Working area (X/Y)	540 x 375 mm (21" x 15")	650 x 530 mm (25.6" x 20.8")
Resolution (X/Y)	7.937 µm (0.3125 mil)	1 µm (0.04 mil)
Repeatability	±0.005 mm (±0.2 mil)	±0.001 mm (±0.04 mil)
Precision of front-to-back alignment	±0.02 mm (±0.8 mil)	±0.02 mm (±0.8 mil)
Milling motor	Max. 60,000 rpm, software controlled	3-phase, max. 60,000 rpm, software controlled
Tool change	Manual	Manual, quick-release
Tool collet	3.175 mm (1/8")	3.175 mm (1/8")
Drilling speed	90 strokes/min	120 strokes/min
Travel speed (max)	40 mm (1.575")	100 mm (3.94")
Depth adjustment		Non-contact air-bearing
X/Y positioning system	2-phase stepper motors	3-phase stepper motors, precision lead screw assemblies with internal ball recirculating system
X/Y linear drive	Precision linear bushings and dual shafts	Precision linear bushings and dual shafts
Z drive	Electromagnetic with hydraulic damper	Pneumatic 14 mm (0.55") movement
Machine table base	Precision milled aluminum bed	Precision milled aluminum bed
Dimensions (W/H/D)	600 x 375 x 760 mm (23.6" x 14.75" x 30")	750 x 420 x 900 mm (29.5" x 16.5" x 35.4")
Weight	43 kg (95 lb)	69 kg (151.8 lb)
Power supply	115/230 V, 50–60 Hz, 200 W	115/230 V, 50–60 Hz, 200 W
Compressed air supply	None required	6 bar (87 psi), 100 l/min (3.528 cfm)

Specifications subject to change.

Size of tracks and gaps depends on materials and tools. 100 µm tracks and gaps possible with LPKF MicroCutter on FR4 18/18 µm Cu. More information on materials page 89 and tools page 33.

Feature comparison

of LPKF ProtoMat circuit board plotters

Feature	LPKF ProtoMat					
	S100 Page 7	S62 Page 11	S42 Page 15	H100 Page 19	M60 Page 23	X60 Page 23
Working area						
mm	229 x 305	229 x 305	229 x 305	420 x 380	540 x 375	650 x 530
inch	9" x 12"	9" x 12"	9" x 12"	15" x 16"	21" x 15"	25.6" x 20.8"
Spindle speed (x1,000 rpm)	100	62	42	100	60	60
Head speed * (mm/sec)	150	150	50	150	40	100
Aluminum cutting	●	●	—	●	●	●
Front panel engraving	●	●	●	●	●	●
BoardMaster software	●	●	●	●	●	●
CircuitCAM software version	CircuitCAM PCB	CircuitCAM PCB	CircuitCAM Lite	CircuitCAM PCB	CircuitCAM PCB	CircuitCAM PCB
Tool count	10	10	—	30	—	—
Automatic tool change	●	●	—	●	—	—
Vacuum table option	+	+	+	●	—	—
Fiducial recognition option	+	+	+	●	+	+
Brush head option	+	+	—	—	+	+
Acoustic cabinet	●	●	+	●	+	—
Automatic depth control sensing	—	—	—	●	—	—
Working depth limiter	Pneumatic	Mechanical	Mechanical	Pneumatic	Mechanical	Pneumatic
Connectivity methods	RS-232, USB	RS-232, USB	RS-232, USB	RS-232, USB	RS-232, USB	RS-232, USB
Footprint (W/D)						
mm	650 x 800	650 x 800	580 x 620	650 x 750	620 x 760	750 x 900
inch	25.6" x 31.5"	25.6" x 31.5"	22.8" x 24.4"	25.6" x 29.5"	24.4" x 29.9"	29.5" x 35.4"
Weight	55 kg 121 lb	55 kg 121 lb	43 kg 94.8 lb	50 kg 110 lb	43 kg 94.8 lb	69 kg 151.8 lb
● Standard + Optional — Not available	* Head speed is the speed of the head travelling freely. Milling speed depends on the density of the working material and the spindle speed.					

Plotters

Laser

Plating

Multilayer

SMT/Finishing

Tech Guide

Index

Introduction to ProtoMat accessories, options, tools, and consumables

Contents

Options & Accessories31
for the ProtoMat circuit board plotters

Tools 34
Reliable for the ProtoMat circuit board plotters

Consumables 38
for the ProtoMat circuit board plotters

Plotters

Laser

Plating

Multilayer

SMT/Finishing

Tech Guide

Index

Options & Accessories

Expand the functionality of an LPKF ProtoMat circuit board plotter (and other LPKF equipment) with a variety of precision accessories. Install accessories (such as acoustic cabinets, etc.) onsite and in a matter of minutes.

Most every LPKF ProtoMat circuit board plotter can be enhanced before it ever leaves the factory with the addition of a number of factory-installed options (such as non-contact air-bearing depth limiter). All options are custom-designed to perfectly complement and enhance an LPKF system.



Tools

LPKF's commitment to the highest quality extends to every piece of tooling. Custom-designed for LPKF, these milling, drilling, and routing bits are 100% top-quality carbide, resulting in the longest possible life, precise cuts, and reduced drill flex. Tools are divided into two main groups – 36 mm (1.42") long tools for *surface* work (milling bits and endmills), and 38 mm (1.5") long bits that are intended to work *through* the material, such as contour routers, and drill bits.



Consumables

LPKF produces quality supplies and consumables for all ProtoMat circuit board plotters. From copper-clad material to cleaning pads and adhesives, LPKF realizes that the highest-quality end product must begin with the highest-quality initial components.

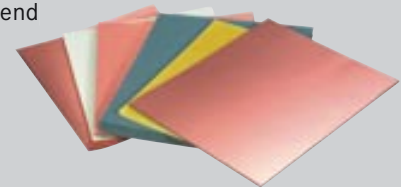

Options & Accessories

for ProtoMat circuit board plotters

Order info

Inside front cover



Expand the capabilities of the ProtoMat and other LPKF systems with a variety of precision accessories and options. These additions, made from the highest quality materials and durably designed for the most challenging prototyping situation, are the perfect complement to any system. Accessories are easy to install at the customer level, and options (such as the non-contact working depth limiter) are options installed at the factory.

- **Increased functionality**
- **Highest quality construction**
- **Perfect integration**

Options & Accessories

Plotters

Laser

Plating

Multilayer

SMT/Finishing

Tech Guide

Index

Options

Fiducial recognition camera

Well-suited for multilayer up to 6 layers!

Use the LPKF fiducial recognition camera to help align a board for multilayer production more quickly and accurately than a pin-only system. The camera also provides for **automatic inspection of the tool bit status** and a **direct measuring function**.

The camera includes driver software that integrates seamlessly with BoardMaster and provides automatic recognition and alignment to existing fiducials in the circuit board. The S-series camera requires USB 2.0 in the host computer, and no additional hardware. The ProtoMat M60/X60 camera includes a special frame-grabber video card and requires an empty peripheral slot in a Windows® computer.

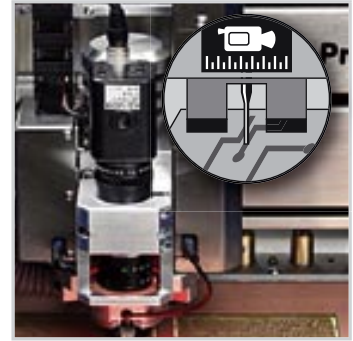

Fiducial recognition camera	ProtoMat S-series camera	ProtoMat M60/X60
Part #	115789	114487

Vacuum tabletop

This option holds the workpiece tightly against the work surface, eliminating any substrate irregularities such as twisting or warpage. The tabletop also prevents the board from slipping after it has been flipped for multi-sided milling or drilling.



Vacuum tabletop	ProtoMat S42	ProtoMat S62 and S100
Part #	117048	115693

Acoustic cabinets

LPKF acoustic cabinets reduce noise and dust emissions, making ProtoMat models even more ideal for CAD offices and electronics prototyping laboratories. The shelving unit is ideal for extra tools and consumables, as well as accessories such as switches and dust extraction mechanisms.



Acoustic cabinets	ProtoMat S42 cabinet	ProtoMat M60 cabinet
Part #	117750	108731
Machine	S42	M-series
Dimensions (W/H/D)	650 x 510 x 800 mm (25.6" x 21" x 31.5")	730 x 1,320 x 950 mm (28.7" x 52.0" x 37.4")
Noise reduction	10 dB	8 dB

Option	LPKF ProtoMat					
	S100	S62	S42	H100	M60	X60
Fiducial recognition camera	+	+	+	●	+	+
Vacuum tabletop	+	+	+	●	-	-
Acoustic cabinet	●	●	+	●	+	-

● Standard + Optional - Not available

Accessories

Dust extraction

The LPKF dust extraction system, complete with a HEPA absolute filter, keeps the work area clean and free of debris of all sizes, from drill shavings to microscopic dust. The milling depth limiter, a precise tool, requires a dust-free surface against which to operate. The integrated AutoSwitch ensures that the dust extraction system is switched on and off automatically. This guarantees safety, increases the lifetime of the dust extraction system and reduces noise when the machine is not running.

Dust extraction	
Part #	114647
Vacuum pressure	Max. 22,500 Pascal
Air flow rate	241 m ³ /hr (0.140 cfm)
Power consumption	800 W (230 V) or 960 W (120 V)
Dimensions (W/H/D)	250 x 300 x 350 mm (10" x 12" x 14")
Acoustic pressure	50 dB(A)
Absolute filter	HEPA filter
Remote control	Controlled by software



Measuring microscope

The LPKF measuring microscope is the ideal tool for calibrating ProtoMat isolation depths, with a built-in light, 60x magnification, and a precision metric scale.

Measuring microscope	
Part #	113495



Precision ring setter

Use the LPKF ringsetter for autochange ProtoMat models to allow different tool use without readjusting the milling depth. Contains adjustment unit and measuring microscope.

Precision ring setter	
Part #	116698



Brush head (only for ProtoMat S-Series and ProtoMat X60)

The brush head, used primarily during rework procedures, helps protect placed components, while maintaining a sufficient low-pressure region for the vacuum system to remove debris from the work area.

Brush head	
Part #	113421



Compressors

LPKF air compressors supply a steady, reliable source of compressed air for systems requiring compressed air.

Compressors	Small compressor	Large compressor
Part #	101092	104863
Tank size (liters)	6	50
Max. pressure	6 bar (116 psi)	10 bar (145 psi)
Output	33 l/min (1.1 cfm)	165 l/min (5.8 cfm)
External Dimensions (W/H/D)	360 x 430 x 360 mm (14.2" x 16.9" x 14.2")	1000 x 770 x 390 mm (39.4" x 30.3" x 15.4")
Weight	21 kg (46.2 lbs.)	56 kg (123.2 lb.)
Acoustic noise level dB(A) at a distance of 4 m (157.5")	52	68
Recommended for	LPKF ProtoPlace	LPKF ProtoMat S100 LPKF ProtoMat H100 LPKF ProtoMat X60



StatusLight

The LPKF StatusLight connects to an LPKF ProtoMat and indicates the status of the machine in such a way that it's visible even across a busy factory floor or in other environments where constant close monitoring is impractical.

Status light	ProtoMat M-Series	ProtoMat H100
Part #	111515	119036



Accessories	LPKF ProtoMat					
	S100	S62	S42	H100	M60	X60
Dust extraction	+	+	+	●	+	+
Measuring microscope	+	+	+	+	+	+
Precision ring setter	+	+	+	+	+	+
Brush head	+	+	-	-	-	+
Compressors	+	-	-	+	-	+
StatusLight	+	+	-	+	+	-

● Standard + Optional - Not available

LPKF milling, drilling and routing tools

Reliable for LPKF ProtoMat circuit board plotters

Order info

Inside front cover



LPKF's commitment to the highest-quality components extends to every piece of tooling. Custom-designed for LPKF, these milling, drilling, and routing bits are 100% top-quality carbide, resulting in the longest possible life, precise cuts, and reduced drill flex. Tools are divided

into two main groups – 36 mm (1.42") long tools for *surface work* (milling bits and endmills), and 38 mm (1.5") long bits that are intended to work *through* the material, such as contour routers, and drill bits.

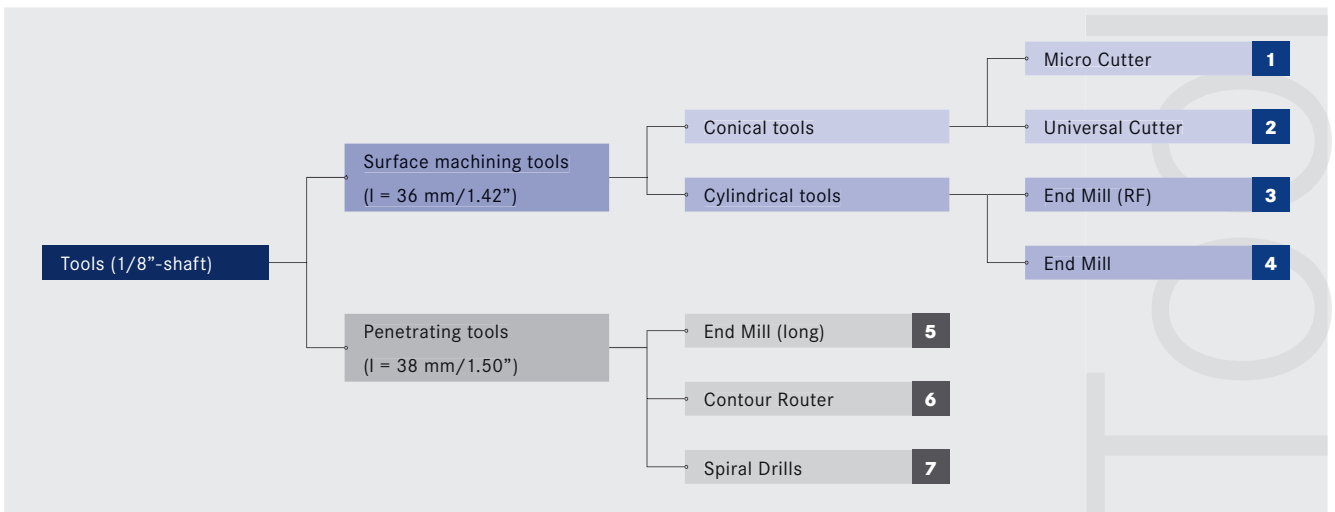

Micro Cutter/Fine-Line Milling Tool 1/8"

Conical custom-designed tool with orange distance ring.

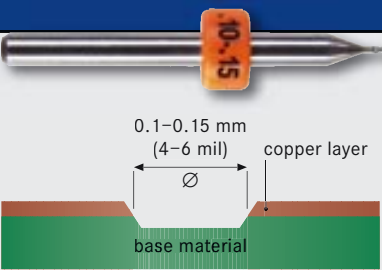
1	Part #	Size	Application
	115836	36 mm, 0.10-0.15 mm (4-6 mil)	For fine isolation tracks on 18 μm copper.

Universal Cutter 1/8"

Conical custom-designed tool with orange distance ring.

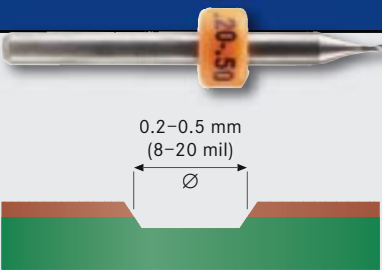
2	Part #	Size	Application
	115835	36 mm, 0.2-0.5 mm (8-20 mil)	For cutting isolation tracks in any copper board material with variable copper thickness.

End Mill (RF) 1/8"

Cylindrical custom-designed tool with blue distance ring.

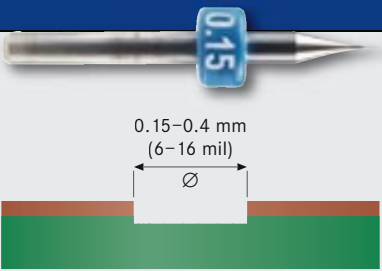
3	Part #	Size	Application
	115832	36 mm, d=0.15 mm (6 mil)	For minimal substrate removal to cut isolation tracks in RF applications.
	115833	36 mm, d=0.25 mm (10 mil)	
	115834	36 mm, d=0.40 mm (16 mil)	

End Mill 1/8"

Cylindrical custom-designed tool with violet distance ring.

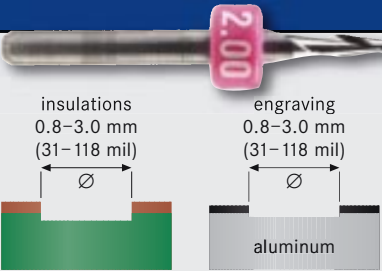
4	Part #	Size	Application
	115839	36 mm, d=0.80 mm (31 mil)	For engraving aluminum front panels, for rub-out areas and wider isolation tracks.
	115840	36 mm, d=1.00 mm (39 mil)	
	115841	36 mm, d=2.00 mm (79 mil)	
	115842	36 mm, d=3.00 mm (118 mil)	

End Mill long 1/8"

Cylindrical custom-designed tool with light green distance ring.

5	Part #	Size	Application
	115837	38 mm, d=1.00 mm (39 mil)	For cutting aluminum and routing soft materials for RF and microwave applications.
	115838	38 mm, d=2.00 mm (79 mil)	

Contour router

Cylindrical custom-designed tool with yellow distance ring.

6	Part #	Size	Application
	115844	38 mm, d=1.00 mm (39 mil)	For routing inner and outer board contours and holes >2.4 mm (>94 mil).
	115845	38 mm, d=2.00 mm (79 mil)	

Spiral Drill

Cylindrical tool with green distance ring.

7	Part #	Size	Application
	115846	38 mm, d=0.20 mm (8 mil)	For drilling holes <2.4 mm (<94 mil).
	115847	38 mm, d=0.30 mm (12 mil)	
	115848	38 mm, d=0.40 mm (16 mil)	
	115849	38 mm, d=0.50 mm (20 mil)	
	115850	38 mm, d=0.60 mm (24 mil)	
	115851	38 mm, d=0.70 mm (28 mil)	
	115852	38 mm, d=0.80 mm (31 mil)	
	115853	38 mm, d=0.85 mm (33 mil)	
	115854	38 mm, d=0.90 mm (35 mil)	
	115855	38 mm, d=1.00 mm (39 mil)	
	115856	38 mm, d=1.10 mm (43 mil)	
	115857	38 mm, d=1.20 mm (47 mil)	
	115858	38 mm, d=1.30 mm (51 mil)	
	115859	38 mm, d=1.40 mm (55 mil)	
	115860	38 mm, d=1.50 mm (59 mil)	
	115861	38 mm, d=1.60 mm (63 mil)	
	115862	38 mm, d=1.70 mm (67 mil)	
	115863	38 mm, d=1.80 mm (71 mil)	
	115864	38 mm, d=1.90 mm (75 mil)	
115865	38 mm, d=2.00 mm (79 mil)		
115866	38 mm, d=2.10 mm (83 mil)		
115867	38 mm, d=2.20 mm (87 mil)		
115868	38 mm, d=2.30 mm (91 mil)		
115869	38 mm, d=2.40 mm (94 mil)		
115870	38 mm, d=2.95 mm (116 mil)		
115871	38 mm, d=3.00 mm (118 mil)		

Tool set with 1/8" shaft and distance rings

For all LPKF ProtoMat models. Includes tools with pressed-on distance rings.

Part #	Content
115909	5x Spiral Drill 1/8", 38 mm (1.5"), d=0.60 (24 mil)
	5x Spiral Drill 1/8", 38 mm (1.5"), d=0.70 (278 mil)
	5x Spiral Drill 1/8", 38 mm (1.5"), d=0.80 (31 mil)
	5x Spiral Drill 1/8", 38 mm (1.5"), d=0.90 (35 mil)
	5x Spiral Drill 1/8", 38 mm (1.5"), d=1.00 (39 mil)
	2x Spiral Drill 1/8", 38 mm (1.5"), d=1.10 (43 mil)
	2x Spiral Drill 1/8", 38 mm (1.5"), d=1.30 (51 mil)
	2x Spiral Drill 1/8", 38 mm (1.5"), d=1.50 (59 mil)
	2x Spiral Drill 1/8", 38 mm (1.5"), d=3.00 (118 mil)
	1x Contour Router 1/8", 38 mm (1.5"), d=1.00 (39 mil)
	1x Contour Router 1/8", 38 mm (1.5"), d=2.00 (79 mil)
	2x End Mill 1/8", 36 mm (1.4"), d=1.00 mm (39 mil)
	1x End Mill 1/8", 36 mm (1.4"), d=2.00 (79 mil)
	2x End Mill (RF) 1/8", 36 mm (1.4"), d=0.40 (16 mil)
	10x Universal Cutter 1/8", 36 mm (1.4"), 0.2–0.5 mm (8–20 mil)



RF and Microwave Set with distance rings

Part #	Contents
116394	Tools with distance rings:
	5x End Mill (RF) 1/8", 36 mm, d=0.25 mm (10 mil)
	3x End Mill (RF) 1/8", 36 mm, d=0.40 mm (16 mil)
	3x End Mill (RF) 1/8", 36 mm, d=0.15 mm (6 mil)
	5x End Mill 1/8", 36 mm, d=1.00 mm (39 mil)
	x2 End Mill 1/8", 36 mm, d=2.00 mm (79 mil)
	2x End Mill 1/8", 38 mm, d=2.00 mm (79 mil)

The tool sets may differ depending on your country of origin. Please contact your local representative for details (page 108).

LPKF recommends only tools manufactured by LPKF and assumes no liability for machine damage or work quality when non-LPKF tooling is used.

Consumables

for ProtoMat circuit board plotters

Order info

Inside front cover



LPKF produces the highest-quality supplies and consumables for all ProtoMat circuit board plotters. From copper-clad material to cleaning pads and adhesives, LPKF realizes that the highest-quality end products must begin with the highest-quality starting components.

Plotters

Laser

Plating

Multilayer

SMT/Finishing

Tech Guide

Index

Consumables

Startersets (for first ProtoMat use)

LPKF Startersets are comprehensive collections of work material, bits, and other accessories designed to reduce

startup time by supplying all needed components. Startersets are recommended individually for each ProtoMat.

Machine	Part #	Content
	117527	10x Drill underlay material 229 x 305 mm (9" x 12"), 2 mm (0.08") (predrilled)
		10x Base plate FR4, 229 x 305 mm (9" x 12"), 0/35 µm (predrilled)
		5x Base plate FR4, 229 x 305 mm (9" x 12"), 35/35 µm (predrilled)
		5x Base plate FR4, 229 x 305 mm (9" x 12"), 18/18 µm (predrilled)
		5x Micro Cutter with distance ring 1/8", 36 mm (1.4"), d=0.1-0.15 mm (4-6 mil)
		3x End Mill (RF) with distance ring 1/8", 36 mm, d = 0.15 mm (6 mil)
		10x End Mill (RF) with distance ring 1/8", 36 mm (1.4"), d=0.25 mm (10 mil)
		3x End Mill (RF) with distance ring 1/8", 36 mm (1.4"), d=0.40 mm (16 mil)
		5x End Mill with distance ring 1/8", 36 mm (1.4"), d=1.00 (39 mil)
		2x End Mill with distance ring 1/8", 36 mm (1.4"), d=2.00 (79 mil)
		2x End Mill with distance ring 1/8", 38 mm (1.5"), d=2.00 (79 mil)
		1x Tool Set 1/8" shaft with distance rings
		1x Special tape
		3x PCB cleaner
LPKF ProtoMat S62	115791	10x Drill underlay material 229 x 305 mm (9" x 12"), 2 mm (0.08") (predrilled)
		10x Base plate FR4, 229 x 305 mm (9" x 12"), 0/35 µm (predrilled)
		5x Base plate FR4, 229 x 305 mm (9" x 12"), 35/35 µm (predrilled)
		5x Base plate FR4, 229 x 305 mm (9" x 12"), 18/18 µm (predrilled)
		5x Fine line milling with distance ring 1/8", 36 mm (1.4"), d=0.1-0.15 mm (4-6 mil)
		5x End Mill (RF) with distance ring 1/8", 36 mm (1.4"), d=0.25 mm (10 mil)
		1x Tool Set 1/8" shaft with distance rings
		1x Special tape
LPKF ProtoMat S42	117717	3x PCB cleaner
		10x Drill underlay material 229 x 305 mm (9" x 12"), 2 mm (0.08") (predrilled)
		10x Base plate FR4, 229 x 305 mm (9" x 12"), 0/35 µm (predrilled)
		5x Base plate FR4, 229 x 305 mm (9" x 12"), 35/35 µm (predrilled)
		1x Tool Set 1/8" shaft with distance rings
LPKF ProtoMat H100	113867	1x Special tape
		3x PCB cleaner
		10x Base plate FR4, A3, 35/35 µm
		10x Base plate FR4, A4, 18/18 µm
		10x Base plate FR4, A3, 18/18 µm
		10x End Mill 1/8", 38 mm (1.5"), d=1.00 (39 mil)
		10x End Mill (RF) 1/8", 36 mm, d=0.25 mm (10 mil)
LPKF ProtoMat M60/X60	102377	10x Micro Cutter 1/8", 36 mm, 0.1-0.15 mm (4-6 mil)
		1x Tool Set 1/8" shaft
		4x Honeycomb material for vacuum table
		1x PCB cleaner
		5x Drill underlay material A4, 2 mm (0.08")
		5x Drill underlay material A3, 2 mm (0.08")
		5x Base plate FR4, A4, 0/35 µm
		2x Base plate FR4, A4, 35/35 µm
		3x Base plate FR4, A4, 18/18 µm
		5x Base plate FR4, A3, 0/35 µm
5x Base plate FR4, A3, 35/35 µm		
5x Micro Cutter 1/8", 36 mm (1.4"), 0.1-0.15 mm (4-6 mil)		
5x End Mill (RF) 1/8", 36 mm (1.4"), d=0.25 mm (10 mil)		
1x Tool Set 1/8" shaft		
1x Special tape		
3x PCB cleaner		

These kits may differ depending on your country of origin.
Please contact your local representative for details (page 108).

Multilayer sets for multilayer PCB production

LPKF multilayer startersets include all materials necessary to fabricate the highest-quality multilayer boards, using a ProtoMat circuit board plotter and a MultiPress II.

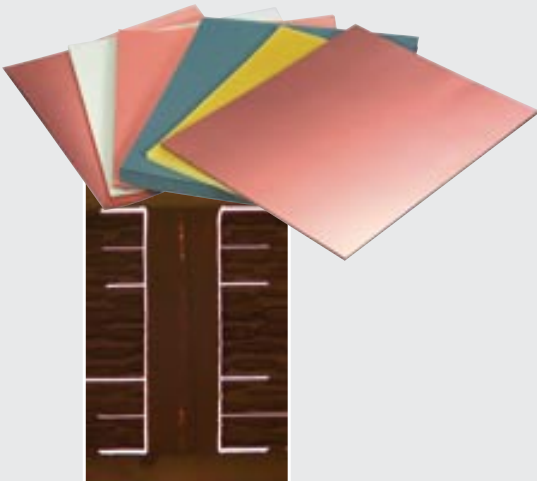
Part #	Description	Content
119612	4-layer multilayer set	Size of material: 229 x 306 mm (9" x 12")
		Base material for 10 multilayers with 4 layers
		20x laminate multilayer 0/5 µm (229 x 305 x 0.2 mm) (9" x 12" x 0.001") with protection foil
		40x Prepreg (275 x 200 x 0.1 mm) (10.8" x 7.9 x 0.004")
		60x Pressing cardboard cushion (229 x 305 mm) (9" x 12")
		10x Base plate FR4 18/18 µm (229 x 305 x 1 mm) (9" x 12" x 0.04")
119613	6-layer multilayer set	Size of material: 229 x 305 mm (9" x 12")
		Base material for 10 multilayers with 6 layers
		20x laminate multilayer 0/5 µm (229 x 305 x 0.2 mm) (9" x 12" x 0.001") with protection foil
		60x Prepreg (275 x 200 x 0.1 mm) (10.8" x 7.9 x 0.004")
		60x Pressing cardboard cushion (229 x 305 mm) (9" x 12")
		20x Base plate FR4 18/18 µm (229 x 305 x 0.36 mm) (9" x 12" x 0.014")

Drill underlay material and parts for vacuum table

raises the board from the work surface to avoid damage to the table during drilling. LPKF drill underlay boards help prevent drilling debris from clinging to bits.

The honeycomb material for vacuum table supports the workpiece perfectly. Also the sinter backing plates can be changed separately

Part #	Description	Boards per package
116148	Honeycomb material for desktop vacuum table for ProConduct® and ProtoMat S-series vacuum table, 5 mm thick, Ø 3.5 mm	4
114297	Honeycomb material for vacuum table for the ProtoMat H100, 5 mm thick, Ø 3.5 mm	4
116099	Sinter backing plate for vacuum table for ProtoMat S-series	4
116002	Sinter backing plate for vacuum table for ProtoMat H100	2
106388	Drill underlay material, DIN A4, d=2 mm	10
106389	Drill underlay material, DIN A3, d=2 mm	10
115966	Drill underlay material (predrilled), 229 mm x 305 mm (9" x 12"), d=2 mm	10



Copper-clad FR4 board material

(1.5 mm thickness)

Part #	Description	Boards per package
115971	Base plate FR4, 229 mm x 305 mm (9" x 12"), 5/5 µm with protective Cu-foil, predrilled with 3 mm registration holes	10
115968	Base plate FR4, 229 mm x 305 mm (9" x 12"), 0/18 µm, predrilled with 3 mm registration holes	10
115967	Base plate FR4, 229 mm x 305 mm (9" x 12"), 18/18 µm, predrilled with 3 mm registration holes	10
115969	Base plate FR4, 229 mm x 305 mm (9" x 12"), 0/35 µm, predrilled with 3 mm registration holes	10
115970	Base plate FR4, 229 mm x 305 mm (9" x 12"), 35/35 µm, predrilled with 3 mm registration holes	10
112059	Base plate FR4, A3, 5/5 µm with protective Cu-foil	10
106398	Base plate FR4, A3, 18/18 µm	10
106400	Base plate FR4, A3, 0/35 µm	10
106401	Base plate FR4, A3, 35/35 µm	10

**Multilayer material**

Part #	Description	Boards per package
119574	Base plate FR4 18/18 µm, 229 x 305 (k) x 1 mm (9" x 12" x 0.04")	1
119575	Base plate 104 ML, 18/18 µm, 229 x 305 (k) x 0.36 mm (9" x 12" x 0.01")	1
119571	Thin laminate 104 ML, 5/0 µm, 229 x 305 (k) x 0.2 mm (9" x 12" x 0.008") with protection Cu-foil	1
119572	Prepreg type 2125, 275 (k) x 200 x 0.1 mm (10.8" x 7.9" x 0.004") for multilayer	2
119573	Pressing cardboard cushion for multilayer, 229 x 305 x 0.1 mm (9" x 12" x 0.004")	1
119577	Pressing metal sheet for MultiPress II, 229 x 305 x 0.4 mm (9" x 12" x 0.016")	1

Cleaning pad

Part #	Description	Pads per package
106403	Metal-free ultra-fine PCB cleaning pads remove oxidation from the copper surface of a work piece.	10

**Adhesive tape**

Part #	Description
106373	Masking tape to hold work material flat to the work surface and leave no residue or contamination behind.



LPKF CircuitCAM and BoardMaster

Comprehensive software package

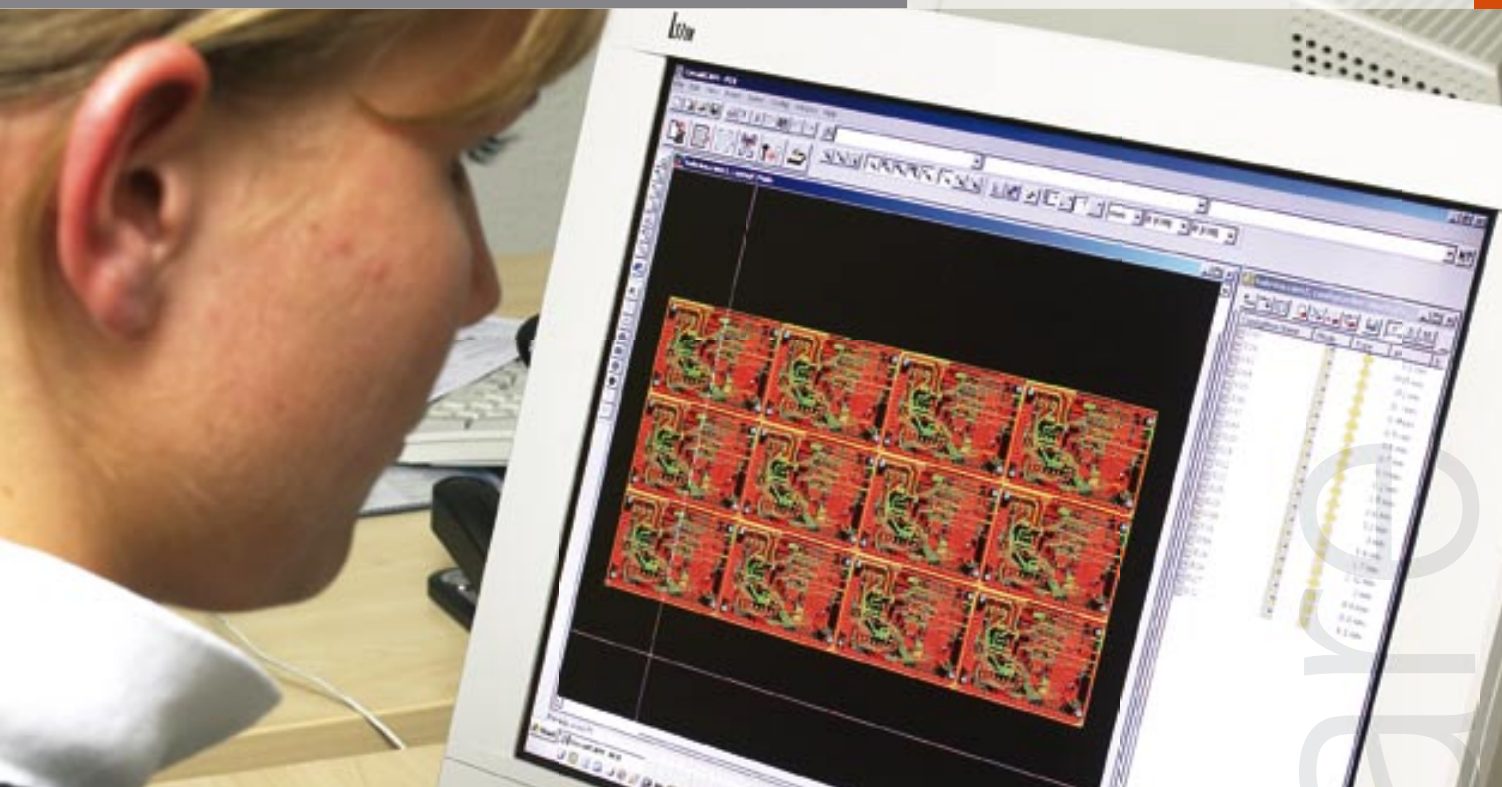
[Order info](#)
[Inside front cover](#)

Plotters

Laser

Plating

Multilayer

SMT/Finishing

Tech Guide

Index

Each LPKF circuit board plotter includes a comprehensive software package for importing data from any PCB layout CAD package and controlling the circuit board plotter. This software is designed to be simple to use, perfectly matched to the hardware, and compatible with all standard CAD programs.

LPKF CircuitCAM PCB imports design data from virtually every known design package, and allows the user to modify or change the layout on-the-fly.

LPKF BoardMaster prepares layout files to send to any LPKF circuit board plotter. Additionally, LPKF BoardMaster allows the layout to be manipulated – such as duplication, rotation, or tiling. LPKF BoardMaster also controls the LPKF circuit board plotter.

These minor variations of the software are used in specialized applications:

LPKF CircuitCAM Lite is a version of CircuitCAM PCB, optimized for the more economical LPKF ProtoMat S42.

LPKF CircuitMaster is a version of BoardMaster PCB that is optimized for full control of the LPKF ProtoLaser 200.

LPKF CircuitCAM – the software interface to your CAD/EDA system

Simple and functional

A software wizard guides even inexperienced users through the program sequence step-by-step, from data import, through path generation, to the export of production data. LPKF CircuitCAM processes the same data and data files required by a commercial board fabricator. CircuitCAM automatically imports aperture tables and tool lists, followed by Gerber and NC drilling files:

- **Data import:** Imports Gerber®, GerberX, HP-GL™, Excellon®, Sieb & Meier, DXF, Barco®, ODB++®
- **Data export:** Exports Gerber®, GerberX, HP-GL™, LMD, Excellon®, DXF formats
- **Intelligent insulation:** This process guarantees removal of copper using various automatic and individually adjustable insulation options, reducing milling time and increasing tool life, with up to four different tools per insulation strategy and freely definable rub-outs – including polygons.

- **Design rule check:** Checks track/gap spaces.
- **Auto contour routing:** Automatically generates routing paths with definable breakout tabs.
- **Auto ground plane:** Automatically generates ground planes.
- **Direct drawing input:** Draws simple front panels or printed circuit boards.
- **Editing directly:** For example, modifying line-widths, changing hole diameters, shifting holes, adding copper areas, etc.
- **Software wizard:** Integrated program assistant guides the user and reduces the learning curve.
- **True type fonts:** CircuitCAM understands TTF and TTC during text functions.
- **Auto assign:** Automatically assigns production phases/tools for BoardMaster.
- **Machining order control:** Modifies cutting direction and sequence.



Specification table

	LPKF CircuitCAM LITE	LPKF CircuitCAM PCB
Import formats	Gerber Standard (RS-274-D), Extended Gerber (RS-274-X), Excellon NC Drill (version 1 and 2), Sieb & Meier NC Drill, HP-GL™	Gerber Standard (RS-274-D), Extended Gerber (RS-274-X), Excellon NC Drill (version 1 and 2), Sieb & Meier NC Drill, HP-GL™, Barco® DPF, AutoCAD™ DXF, ODB ++®
Supported shapes	Circle, square, rectangle (also rounded or angled), octagon, oval, marker, IEC 1182 (1000–1024) including thermal reliefs, fiducials, etc., special (arbitrary definable)	
Export formats	LPKF BoardMaster (LMD)	LPKF BoardMaster (LMD), Gerber Standard (RS-274-D), Gerber Extended (RS-274-X), Excellon NC Drill, HP-GL™, DXF
Editing functions	Original modification, relocating, duplicating, rotating, mirroring, erasing, extending/severing lines, line/path extension/shortening, line path/segment parallel shifting, line path/object polygon conversion (Fill), curve linking/closing	
Special functions	Contour routing path generator with breakout tabs	Routing path generator with breakout tabs, volume operations, joining/separating objects, step & repeat (multiple PCB), polygon cut-out, ground plane generation with defined clearance, batch functions
Display functions	Zoom window (freely definable), zoom in/out, overview, redraw, individual layers selectable/visible, panning (keyboard), layer in solid/outline/center line display, 16 pre-set colors (up to 16 million freely available), different colors for tracks and pads of the same layer, different colors for insulation tools	
Marker functions	Single element, total layer, all layers, pad groups, selection and limiting to specific layers possible for lines/polygons/circles/rectangles/pads/holes (multiple choice and restriction to specific layers possible)	
Graphic functions	Lines (open/closed), circle, polygon, rectangle, pad, hole, text (TTF, TTC)	
Control functions	Measuring	Measuring, design rule check
Insulation methods	Single insulation method, additional multiple insulation of pads, removal of residual copper spikes (spike option), milling out of large insulation areas (rub-out), concentric or in serpentine maintaining minimum insulation spaces, zone insulation (only PCB version), inverse insulation	
Insulation tools	1–2 tools	1–4 tools
Languages	English, German, French, Spanish, Japanese and Chinese	
Hard-/software requirements	Microsoft® Windows® 2000/XP, 1.2 GHz processor or better, min. 512 MB RAM, screen resolution min. XGA	
Supplied with	LPKF ProtoMat S42 *	LPKF ProtoMat S62, S100, H100, M60, X60 and ProtoLaser 200

* Upgrade from LITE to PCB available. Specifications subject to change.

LPKF BoardMaster – the powerful and comfortable control software

LPKF's BoardMaster software combines a user-friendly interface with precision process control. The software accepts milling and drilling data created by CircuitCAM, as well as HP-GL™ files from various design software packages.



User-friendly operating interface

BoardMaster's WYSIWYG interface shows all milling and drilling data as well as the size of the base material. Simple mouse clicks rotate and move layouts, as well as creating step-and-repeat copies of layouts on the workpiece. BoardMaster constantly displays process status.

Intelligent tool management

LPKF BoardMaster controls all tool parameters, such as feed rate and tool RPM. BoardMaster monitors bit life and prompts for a tool change at appropriate times. Tool changes are kept at a minimum by BoardMaster's optimizing monitoring process.

Automatic data transmission

All processing phases and associated tool data are transferred directly from CircuitCAM to BoardMaster. Production can start immediately.

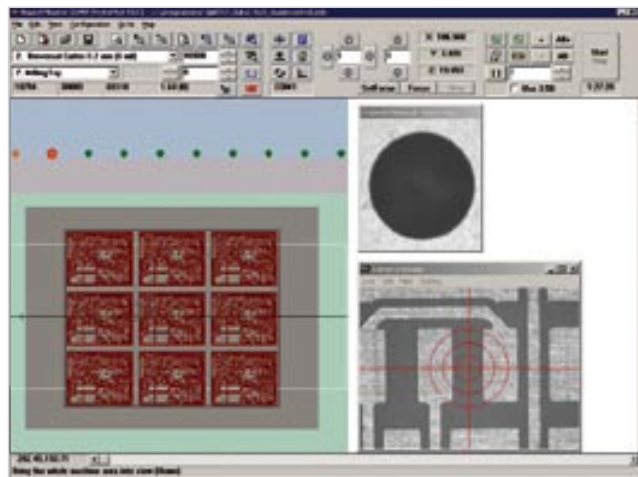

Specification table

LPKF BoardMaster	
Import formats	LPKF-Mill-Drill (*.LMD), HP-GL™
Control	All ProtoMat circuit board plotters
Display functions	WYSIWYG display of machining data, zoom in/out/working area/projects, previous view, all viewing methods available at all times, even during the machining process, graphical display of the current head position
Placement functions	Copy, move, step and repeat, handles multiple artworks and placements simultaneously
Selection methods	Total production phase, specific tools, individual drill holes/lines/segments, selection from/up to a specific hole/line segment
Tool management	RPM and head down time, travel speed, registering and saving actual tool life, initiating the tool change procedure if tool lifetime is exceeded, working mode profiles customized for ProtoMat models
Tool library	Unlimited, individual library for different material types, individual customizable parameters
Programming material size	Positioning with corner coordinates, with the mouse, coordinates input via keyboard, option of saving frequently used material sizes
Languages	English, German, Spanish, Japanese, French, Chinese
Other	Acoustic signal at end of production phase and display of production time remaining, estimated production time is displayed before start, integration of a camera option with automatic fiducial recognition, Check for broken tools
Hardware and software requirements	Microsoft® Windows® 2000/XP, 1.2 GHz processor or better, min. 256 MB RAM, screen resolution XGA, serial port or USB
Specifications subject to change.	

LPKF ProtoLaser 200

Direct laser structuring of circuit boards



Item	LPKF ProtoLaser 200
Part #	118188
Order info	Inside front cover



- Plotters
- Laser**
- Plating
- Multilayer
- SMT/Finishing
- Tech Guide
- Index

- **High-speed direct laser structuring**
- **Finest circuit resolution**
- **Ideal for RF and microwave circuitry**
- **Quickly and cleanly removes large rub-out areas**
- **Small production runs on demand**

The LPKF ProtoLaser 200 is a sophisticated laser system, capable of producing ultra-fine structures with an unequalled precision at unbeatable speeds, using a unique process (patent pending).

The LPKF ProtoLaser 200 is a versatile state-of-the-art laser system. The result is a rapid PCB prototyping solution that's perfect for the fine precision geometries demanded by RF, microwave, RFID, antennas, filters, etc.

ProtoLaser 200: Printed circuit structuring at the speed of the light.

This revolutionary laser-based process dramatically accelerates electronics development with a technological breakthrough in speed and precision!

The 60 x 70 mm board shown below was structured in less than 5 minutes!

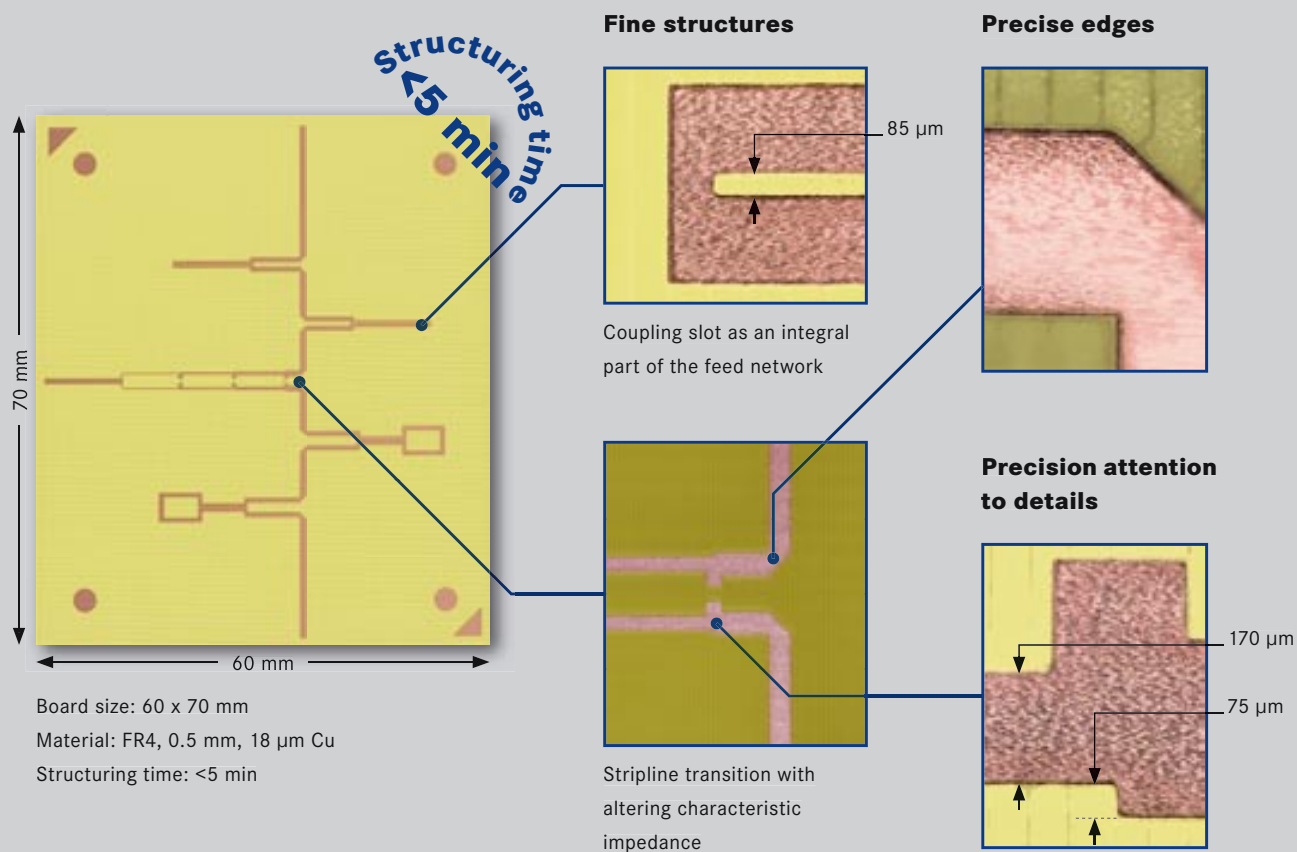

University of Hannover, Institute of High Frequency Technology and Radio Systems
Planar wideband feeding network for balanced antenna structures (frequency range 1-6 GHz)

“The ProtoLaser has allowed us to produce as many as 500 custom filters in just one week! The ability of this system to quickly and accurately produce new design revisions has made the ProtoLaser one of our most important investments in capital equipment.”

Elcom
Technologies

Boris Yasinov, Senior Design Engineer
Elcom Technologies, USA

The LPKF ProtoLaser 200 features:

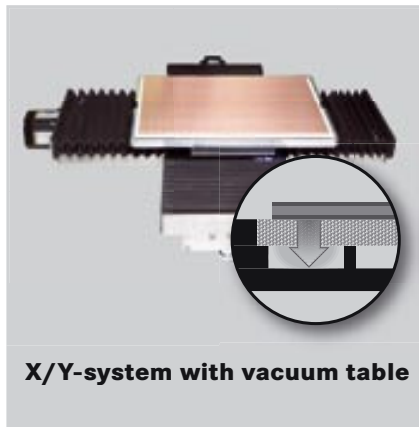

X/Y-system with vacuum table

The integrated XY table precisely moves the workpiece under the laser, positioning the workpiece in accordance with the ProtoLaser's addressable laser fields. An integrated vacuum table holds the workpiece flat against the work surface, without the use of pins or clamps.

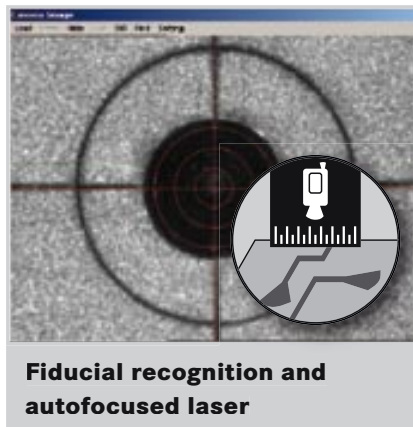

Fiducial recognition and autofocused laser

Precision front-to-back alignment increases tremendously with the fiducial recognition camera. This camera allows the ProtoLaser 200 to properly align the work. The ProtoLaser 200 uses an optical calibration system and a precision Z-drive to adjust the laser beam for the optimal focal point.



Working area 305 x 229 mm (12\"/>

The LPKF ProtoLaser 200's laser system addresses a scan field 100 x 100 mm (4\"/>

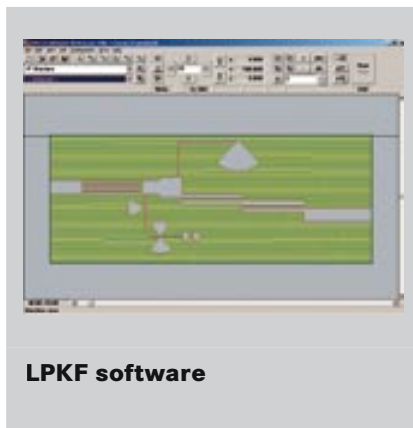

LPKF software

LPKF's CircuitCAM and CircuitMaster software offer powerful direct control over all the function parameters of the ProtoLaser 200. LPKF also includes a wide variety of programmed profiles. Finally, profiles can be further customized.

And many more, such as:

Protective cabinet

The LPKF ProtoLaser 200 is safe to use and environmentally friendly. The protective cabinet keeps the laser at a Class 1 rating and prevents any particles or evaporation from leaving the work area. The cabinet provides an effective noise reduction for a silent working environment.

Vacuum system

The vacuum system reduces and filters the contents of the laser chamber through an efficient dust extraction and filtration system.

Normal power requirements

The ProtoLaser 200 can be configured to operate from an ordinary 230 V line. The system can be integrated in any lab.

Previsualization laser

The ProtoLaser 200 includes a low-power visualization laser tool. This tool projects a reference image on the work surface, outlining the preferred work area.

- ➔ **Structuring speed: 6 cm²/min**
- Laser spot: 25 μm**
- Radius in corners: 12.5 μm**
- Minimum structure size: 50/25 μm lines and spaces**

Applications

Main applications

HDI circuit structuring

The ProtoLaser 200 produces incredibly fine circuit details. Depending on the thickness of the copper layer, areas can be removed at a rate of 6 cm² per minute. The superior performance and speed of the LPKF ProtoLaser make it an ideal component in any engineering environment requiring on-demand small-series rapid PCB production.



Flexible substrates

The ProtoLaser 200 precision copper removal and the integrated vacuum table are the keys to a superior flex-circuit structuring system.



RF substrates (FR4, TMM, etc.)

Manufacture precise microwave and RF circuits with astonishingly high geometric precision using the LPKF ProtoLaser 200. The ProtoLaser's ability to quickly remove and clear away ("rub out") large areas of conductive material while avoiding damage to the substrate addresses a strict requirement of many RF and microwave applications.

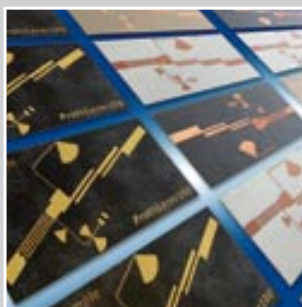

Further applications

RF-IDs on PET foil substrates

The typical process of structuring aluminum-coated substrates is complicated and expensive. The ProtoLaser 200, however, protects the substrate with a proprietary technique (patent pending). Even substrates such as aluminum-coated PET films (50 μm PET film, 9 μm Al) can be structured quickly and easily.



RF filter on ceramic substrates

The ProtoLaser 200 also structures metal-coated ceramics, from patterns as fine as 50 μm lines and 25 μm spaces to as thick as 300 μm copper removal.



Accessories, software and tools



Accessories

More details on page

Compressor 32

LPKF air compressors supply a steady, reliable source of compressed air.

Measuring microscope 31

The LPKF measuring microscope is the ideal tool for work inspection, with a built-in light, 60x magnification, and a precision metric scale.

Adjustment tool set for ProtoLaser 200

This set of precision tools is useful for adjusting the ProtoLaser 200 table and optics, as a part of regular maintenance and service.

Part # **118005**

Dust extraction

The LPKF dust extraction system, complete with a 1 µm activated charcoal filter, keeps the work area clean and free of debris of all sizes.



Part # **117416**



Software (included)

More details on page

LPKF CircuitCAM/CircuitMaster software package 42

The LPKF ProtoLaser uses the CircuitCAM/CircuitMaster software package to import and process data, and to control the laser structuring of work pieces.

CircuitCAM imports a variety of file types, incl. Gerber® Standard (RS-274-D), Gerber® Extended (RS-274-X), DBF (Barco), Excellon® NC Drill (versions 1 and 2), Sieb & Meier NC Drill, DXF, HP-GL™, and ODB++. CircuitMaster controls the fabrication process in real time, driving the ProtoLaser system.

Specification table



This machine is designed as a Class I Laser Product during normal operation. In maintenance mode this system becomes a Class IV Laser Product.

LPKF ProtoLaser 200	
Part #	118188
Max. layout area	100 x 100 x 50 mm (4" x 4" x 2")
Working area	229 x 305 mm (9" x 12") ^a
Structuring speed	Up to 6 cm ² /min (1 inch ² /min)
Beam diameter in focus	25 µm (1 mil)
Minimum track/space	50 µm/25µm (2 mil/1 mil) ^c
Resolution scan field	2 µm (0.08 mil)
Repeatability	±2 µm (±0.08 mil)
Laser pulse frequency	10-100 kHz
Machine dimensions (W/H/D)	1,360 x 1,920 x 1,250mm (53.5" x 75.6" x 49.2") ^b
Machine weight	650 kg (1,433 pounds)
Operation environment specifications	
Electric supply	230 V, 50-60 Hz, 1.4 kW
Compressed air supply	8 bar (116 psi), 160 l/min (3.5 cfm)
Cooling	Air-cooled, no external cooling required
Ambient temperature	20 °C ±2 °C (68 °F ±4 °F)
Exhaust	
Electric supply	230 V, 50 Hz, 1.2 kW
Weight	45 kg (99.2 pounds)
Volume flow	320 m ³ /h, max suction 21,000 PA
Filter	Active carbon filter and new HEPA filter
<p>^a Note that the ProtoLaser 200 can address different fields on a single 229 x 305 mm (9" x 12") workpiece.</p> <p>^b Note that the ProtoLaser 200 requires 2,150 mm (84.6") with the status light installed and requires 2,250 mm (88.6") clearance to open the working door.</p> <p>^c Note that the size of tracks and gaps depend on material and laser parameters.</p> <p>Specifications subject to change.</p>	

Application Notes for the LPKF ProtoLaser 200

For drilling through-holes, an LPKF ProtoMat is a perfect complement to a ProtoLaser 200.

The basic process is:

1. Data prep and import

Use CircuitCAM to import the file and CircuitMaster to transfer the design to the ProtoLaser 200. Use BoardMaster to transfer the design to a ProtoMat circuit board plotter in order to drill fiducials.

2. Drill fiducials

Drill all fiducial alignment marks, using a ProtoMat circuit board plotter.

3. Structure fiducials and circuits

Using the ProtoLaser 200, structure the circuitry.

4. Through-hole plating with ProConduct®

Following the easy-to-learn-process to apply LPKF ProConduct® paste, the PCB will be ready for use very fast – without messy chemicals.

Through-hole conductivity

Although many applications of the LPKF ProtoLaser 200 do not require through-hole conductivity, the ProtoLaser's precision and speed can certainly be a benefit in those circumstances.

Drilling all the way through a substrate is best performed by a separate mechanical milling/drilling machine, such as the ProtoMat H100 or the S100, fitted with a fiducial recognition vision system.

The highest-quality through-hole conductivity LPKF offers that complements the precision of the ProtoLaser is the ProConduct® system – a chemical-free in-house through-hole conductivity solution. In repeated RF and microwave tests, two-sided prototypes using ProConduct® were functionally equivalent to commercially produced galvanic plated prototypes.

Introduction to through-hole plating

Contents

LPKF ProConduct®51

In-house PCB through-hole conductivity without chemicals

Contac III and MiniContac S 55

Professional stand-alone electroplating tank

EasyContac 59

Manual through-hole conductivity for two-layer PCBs

Comparison of through-hole conductivity solutions61

Assuring professional quality through-hole conductivity is critical in the production of state-of-the-art PCB prototypes and breadboards. LPKF offers several solutions to complement its already impressive line

of equipment for producing in-house prototypes. Each solution offers in-house conductivity, reducing prototyping turnaround time and drastically reducing time-to-market in prototyping and development cycles.



The **LPKF ProConduct®** system is a simple-to-use through-hole conductivity solution perfect for small fabrication runs. The ProConduct® system avoids the use of chemical baths by using a manually applied conductive polymer that works quickly and efficiently to plate through-holes in boards of any size or shape.



LPKF's **MiniContac S** and **Contac III** systems are a professional stand-alone chemical through-hole plating solutions, ideal for prototyping situations with multilayer boards or PCBs with high hole count. The chemistry is self-contained and virtually maintenance-free. Reverse pulse plating, offered by the Contac III, assures a regular and efficient plating, even in the smallest diameter through-holes.



For prototyping and ease-of-use, the **LPKF EasyContac** is hard to beat. A manual rivet through-hole conductivity system, the EasyContac lives up to its name – requiring no chemicals or disposal considerations at all and it's easy to master.

Plotters

Laser

Plating

Multilayer

SMT/Finishing

Tech Guide

Index

LPKF ProConduct®

PCB through-hole conductivity without chemicals

Item	LPKF ProConduct®
Part #	115790
Order info	Inside front cover



Plotters

Laser

Plating

Multilayer

SMT/Finishing

Tech Guide

Index

LPKF introduces the ProConduct® through-hole conductivity system, new technology for producing conductive through-holes without chemical electroplating tanks or potentially hazardous chemical processing.

The LPKF ProConduct® through-hole conductivity system is an ideal solution for many in-house rapid PCB prototyping environments. ProConduct® is perfect for low volume production, laboratories or shops where chemical electroplating is impractical, or any circumstance requiring an economical through-hole conductivity solution. Thanks to a parallel process even boards with high hole count are possible.

- **No plating tank or chemicals required**
- **Reliable and thermally stable plating results**
- **Compact, fast and easy to use**
- **Key plating component for PTFE and other difficult substrates (RF)**

Easy to handle

LPKF ProConduct® uses a specially-developed conductive polymer to quickly and easily plate vias in just a few minutes. This four-step easy-to-learn process lends itself well to parallel processing and results in smoothly plated through-holes in a fraction of the time and cost of chemical electroplating:

1 Mill the board with a LPKF circuit board plotter.



Milling the board

2 Apply a special adhesive film to the surface of a milled PCB and drill the through-holes.



Applying the protective film



Drilling the board

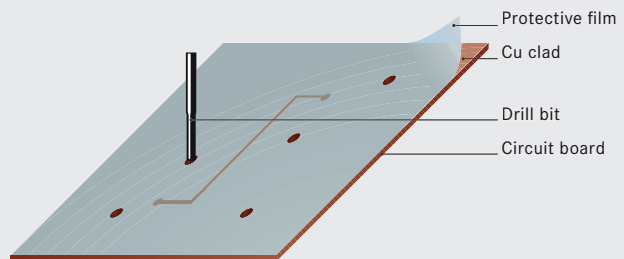
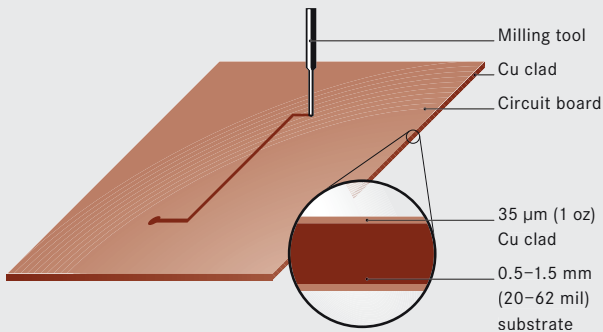

Perfect results

The LPKF ProConduct® system plates vias as small as 0.4 mm (15 mil) up to an aspect ratio of 1:4. Smaller holes are possible under special conditions. The basic process requires only a few minutes for double-sided and even multilayer boards. The electrical resistance of LPKF ProConduct® results is extremely low – approximately 19.2 mΩ, depending on the material thickness (see specifications table).

Key to in-house work

When combined with a LPKF ProtoMat circuit board plotter, the LPKF ProConduct® system becomes a key component to an in-house rapid PCB prototyping solution, featuring security, flexibility, and speed.

“Comparing RF-measurements of filters up to 4 GHz have not shown any difference in RF-characteristics between the ProConduct-paste and standard electroplated vias!”



Dr. Geck, chief engineer at the Institute of Radiofrequency and Microwave Engineering, University of Hanover, Germany

3 Apply the conductive polymer to the PCB to fill the through-holes, then use the vacuum table to remove the excess conductor.



Using the squeegee to apply the conductor



Flipping the board

4 Remove the film, cure the treated PCB in an oven for about thirty minutes.



Removing the film



Curing the polymer in a hot-air oven

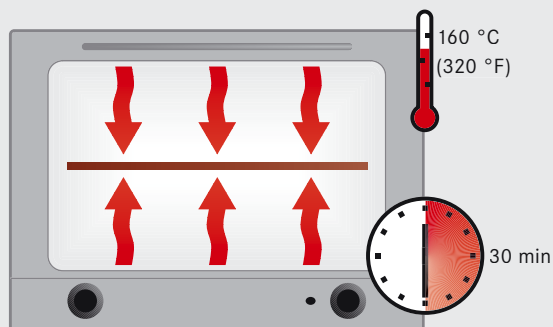
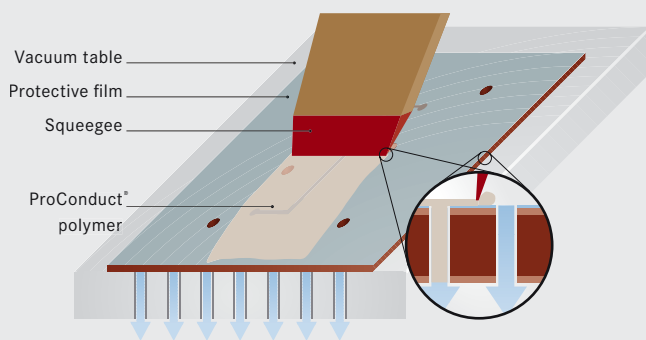

Hot-air convection oven

The resistance of a finished via depends on the diameter, but lies in the range of 10–25 mΩ. After temperature cycling (-40 °F to 250 °F), the resistance value after 250 cycles only increases marginally (max. 28 mΩ, as shown in table, blue bar). The test board used is FR4 double-sided with 35 μm (1 oz/ft²) copper.

Fast temperature change cycles

-40 °C/125 °C (-40 °F/250 °F) @ 1.6 mm (64 mil) FR4 PCB

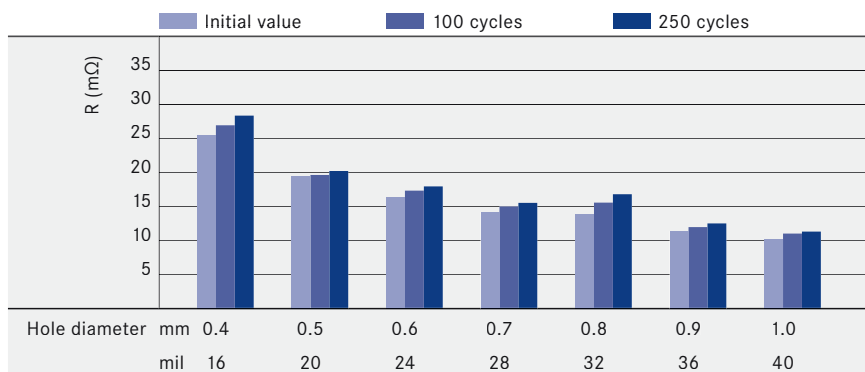

LPKF ProConduct® set

Each LPKF ProConduct® set includes:

Amount	Description
20	Protective film foil
10	Filter fleece
20	2.5 g pack of polymer conductor
1	Screen printing roller
1	Brush
1	Pinch roll
1	PCB cleaner
1	ProConduct® cleaner
1	Work gloves (50 pairs)
1	Lined work gloves

Content subject to change.

Accessories



Accessories



Hot air oven

Hot air oven cures ProConduct® polymer.

Part # **115877**



Desktop vacuum table

Vacuum table specially designed for the ProConduct® system to draw off excess polymer before curing.

Part # **115878**



Vacuum pump

Vacuum pump provides steady vacuum for vacuum table.

Part # **114647**

Specification table

LPKF ProConduct	
Part #	115790
Max. base material	229 x 305 mm (9" x 12")
Min. hole diameter	0.4 mm (15 mil) up to aspect ratio of 1:4 ^a
Number of through-plated holes per circuit board	No limit
Number of layers	4
Solderability	Reflow soldering <220 °C (428 °F), manual soldering ^b
Base material types	FR4, FR3, RF and micromave materials (incl. PTFE based materials)
Process duration	approx. 35 min
Resistance (hole diameter 0.4–1.0 mm at 1.6 mm (63 mil) material thickness)	Average 19.2 mΩ with SD of 7.7 mΩ

^a Smaller holes on request

^b Ask for recommended types of solder

Specifications subject to change.

LPKF Contac III and LPKF MiniContac S

Professional stand-alone electroplating tanks

Item	LPKF Contac III	MiniContac S
Part #	111253	114662
Order info	Inside front cover	



The LPKF Contac III is an electroplating solution ideal for any rapid PCB prototyping situation, featuring Reverse Pulse Plating and unmatched ease-of-use. This LPKF through-hole plating system is specially developed for the professional production of prototype and small batch production printed circuit boards to be used in combination with an LPKF circuit board plotter.

The LPKF MiniContac S is an electroplating solution ideal for any rapid PCB prototyping situation, especially small runs and compact work locations. The LPKF MiniContac S PCB electroplating system is a compact and economical through-hole plating solution, ideal for double-sided and multilayer circuit boards, which employs reliable formaldehyde-free Blackhole® Technology for direct metallization.



- **No analysis or special chemical knowledge needed**
- **Compact, fast and easy to use**
- **Ideal for creating multilayer printed circuit boards**
- **Only four chemical baths**

Plotters

Laser

Plating

Multilayer

SMT/Finishing

Tech Guide

Index

Contac III
MiniContac S

More production reliability with LPKF Contac III and MiniContac S systems



Conventional through-hole plating method (bone effect)

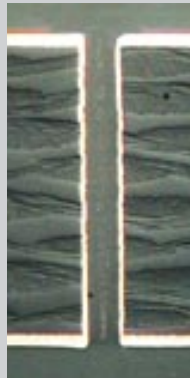

Reverse pulse plating

Reverse Pulse Plating

The LPKF Contac III system uses reverse pulse plating, preventing the “bone effect” (thicker copper growth at hole entrances) that can plug some vias before they are completely plated. This also produces more uniform copper plating for difficult aspect ratios and smaller holes. Reverse pulse plating is also very useful for small holes on high density PCBs and improves production reliability during soldering. Reverse pulse plating uses precisely controlled reverse pulses (anodic polarization of the workpiece) to remove excess material during the plating process.

Please find more information on reverse pulse plating process on page 96.

Maintenance

The LPKF Contac III and MiniContac S are maintenance-free. No chemical knowledge or background is necessary and the chemical process requires no maintenance. The cleaning baths are simply replaced every three months, and the other chemicals are replaced once a year.



Environmental requirements

The through-hole plating process starts with the pre-treatment of the circuit boards. First, they are degreased, then pre-treated, and then activated. This process takes about 35 minutes. Then the circuit boards are copper-coated in a galvanic bath for 60 to 90 minutes. The system is completely closed – the chemicals remain in the tanks during use and the only external connection is a cold water supply for rinsing. One set of chemicals lasts approximately one year.



Applications

The LPKF Contac III and MiniContac S are ideal for following applications:

Versatile plating technology

Plating most common circuit board materials, including FR4 (G10), FR5, and microwave substrates such as RO3000®, RO4000® and TMM®.

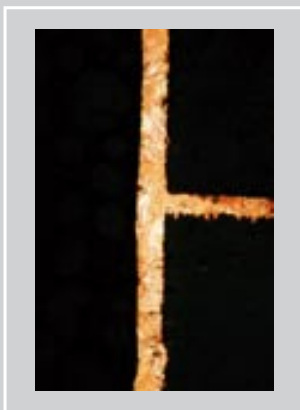

High-quality multilayer plating

Creates up to six-layer printed circuit boards (LPKF Contac III).



Options

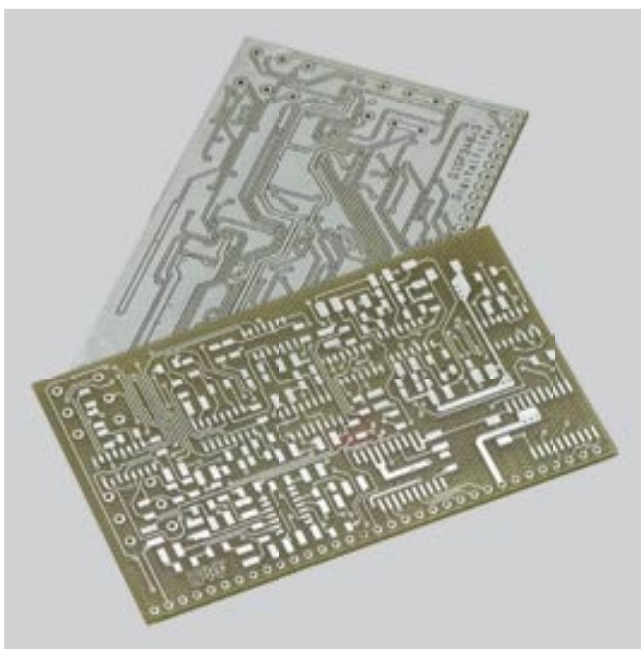

Chemical tinning for LPKF Contac III

For the Contac III, LPKF offers the additional option of a heated tank to provide chemical tin plating for optimal soldering of through-hole plated circuit boards and oxidation protection. Chemical tinning includes: heating device, temperature control and fill level indicator for existing tinning tank.

Part # [108267](#)

Consumables

Product	Part #	Description
Plating chemicals – MiniContac S	114805	First filling of plating chemicals for MiniContac S, including 5 l Cleaner 110, 5 l Cleaner 210, 4 l Activator 310, 15 l Copper Plater 400, and 0.25 l Shine 400
Plating chemicals – Contac III	112400	One year supply of plating chemicals for Contac III systems, including 52 l Cleaner 110, 40 l Cleaner 210, 10 l Activator 310, 40 l Copper Plater 400, and 0.5 l Shine 400
Tin-based bright dip – Contac III	109131	1 l sufficient for 40 PCB's of size 100 x 160 mm. Contains one pack of 900 g and 3 packs of 90 g tin powder.
Cleaner 110	107914	1 l (1 quart) of Cleaner solution
Cleaner 210	107915	1 l (1 quart) of Cleaner solution
Activator 310	107916	1 l (1 quart) of Activator solution
Copper Plater 400	102439	1 l (1 quart) of Copper plater solution
Shine 400	107917	1 l (1 quart) of Shine solution

Specifications

	LPKF Contac III	LPKF MiniContac S
Part #	111253	114662
Activator	Carbon	Carbon
Max. base material size	360 x 420 mm (14.2" x 16.5")	230 x 330 mm (9.0" x 13.0")
Max. board size	270 x 330 mm (10.6" x 13.0")	130 x 250 mm (5.1" x 9.8")
Hole diameter	0.2 mm (8 mil)	0.4 mm (16 mil)
Number of plated holes	Unlimited	Unlimited
Max. number of layers	6	4
Max. resistance	<10 mΩ	<10 mΩ
Environmental compatibility	Good	Good
Processing reliability	Very good	Very good
Process duration	90–120 min	90 min
Base material types	FR4, RO3000®, RO4000®, TMM® *	FR4, RO3000®, RO4000®, TMM® *
Power supply	230 V/50–60Hz, max. 2.0 kW **	115/230 V/50–60Hz, 0.6 kW
Ambient temperature	18–25 °C (64.4–77 °F)	18–25 °C (64.4–77 °F)
Dimensions (W/H/D)	1,150 x 1,110 x 715 mm (45.3" x 43.7" x 28.1")	600 x 550 x 550 mm (23.6" x 21.7" x 21.7")
Optional chemical tinning	Yes	No
Reverse pulse plating	Yes	No

* Further materials upon request.

** 115 V upon request.

Specifications subject to change.

LPKF EasyContac

Manual through-hole conductivity for two-layer PCBs

Item	LPKF EasyContac
Part #	110914
Order info	Inside front cover



EasyContac, a manual system for providing through-hole conductivity for double-sided boards, is ideal for situations where a fast, chemical-free, economical solution is required.

The LPKF EasyContac plates PCB through-holes using simple tools that are easy to operate. With very little effort, small projects can be economically processed, without the use of speciality tools or tanks or chemicals. In particular, the LPKF EasyContac is perfect for projects where 2-sided soldering is impractical. All necessary tooling is included with each set.

- **Economical and fast for small projects**
- **Requires no special tooling**
- **Easy to learn**

EasyContac

Plotters

Laser

Plating

Multilayer

SMT/Finishing

Tech Guide

Index

Ideal for small projects

The LPKF EasyContac system was specifically developed for prototype circuit boards and PCB repairs with up to fifty through-holes per circuit board.

Portable toolset

All the necessary parts are conveniently packed in a portable toolcase, perfect for field engineers. Each set includes:

Amount	Description
1	Automatic punch tool with stamp tip A for 0.6 (24 mil) and 0.8 mm (32 mil) (inner diameter) rivets
1	Tool tip B for 1.0 (40 mil) and 1.2 mm (48 mil) (inner diameter) rivets
1	Pair of tweezers
1	Anvil plate
Copper alloy rivets	
1,000	0.8 mm (32 mil)
1,000	1.0 mm (40 mil)
1,000	1.2 mm (48 mil)
1,000	1.4 mm (56 mil)
The internal diameter is 0.2 mm (8 mil) or 0.4 mm (16 mil) smaller than the desired external diameter.	
Content subject to change.	

Easy to learn

Rivets are simply placed in the through-holes, supported by a backing plate, and riveted with a stamping tool. A touch of solder completes the connection.

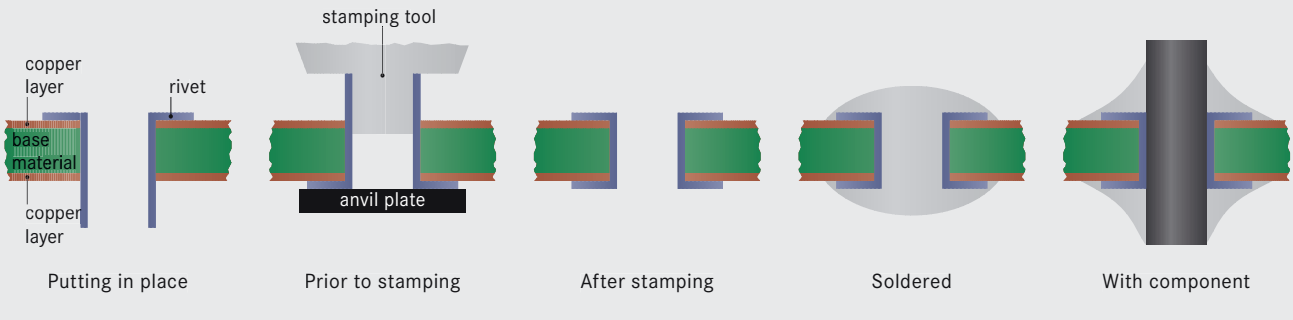

Specification table

LPKF EasyContac	
Part #	110914
Max. base material size	No limit
Number of layers	2
Maximum resistance	10 mΩ
Environmental compatibility	Excellent
Through-plated holes/min	2 or 3
Process reliability	Good
Base material types	FR4, 1.5 mm (59 mil) thickness
Specifications subject to change.	

Comparison of through-hole conductivity solutions

LPKF offers three different through-hole conductivity solutions for the rapid PCB environment. Each enjoys a unique set of features and is uniquely applicable to a set of applications.

The application best determines the method of creating through-hole conductivity. Characteristics such as the size of the workpiece and the size of the production run are key, as well as special factors, such as certain substrates, circuit types, and other conditions.

Solutions	LPKF ProConduct®	LPKF Contac III/MiniContac S	LPKF EasyContac
Conditions			
Small production run, low hole count Although the Contac III/MiniContac S and ProConduct® systems will perform well for small production runs and low hole count boards (less than fifty holes), the EasyContac system is designed specifically for such applications.	✓		
Small production run, high hole count For small production runs, the ProConduct® system, Contac III and MiniContac S plate any number of holes quickly and easily.			
Medium production run For medium production runs, the Contac III and MiniContac S electrochemical plating solutions are the ideal solution. These tanks quickly process circuit boards of a variety of shapes and sizes, consistently producing copper-plated through-holes.			✓
Difficult surfaces Substrates that possess particular challenges, such as pure PTFE.			✓ ✓
RF/microwave circuitry The strict geometric requirements of RF/microwave circuitry are best served by the LPKF ProConduct®.			✓
Tin plating For applications requiring tin-plated surfaces, LPKF's Contac III electrochemical through-hole plating system includes the option of a heated tank for tin plating.			✓*
Chemical concerns For environments and laboratories where chemicals are a concern, the LPKF EasyContac and ProConduct® both provide excellent through-hole conductivity, without a single chemical bath.	✓		✓
High-power circuitry High-power circuitry requires larger holes and heavier plating and for these applications, LPKF recommends using the Contac III electroplating product.			✓*
Reverse pulse plating The LPKF Contac III uses reverse pulse plating to achieve substantially cleaner results in through-hole plating. Reverse pulse plating provides a more uniform coating of copper and prevents the build-up and clogging of copper at the mouths of the through-hole.			✓*

* only Contac III

Introduction to multilayer board production

Contents

LPKF MultiPress II 63
 Bench-top pneumatic press for multilayer PCBs
Special notes 65

Plotters

Laser

Plating

Multilayer

SMT/Finishing

Tech Guide

Index

In any rapid PCB prototyping situation, keeping the process as simple and as quick as possible is paramount to a successful operation. The sooner a prototype is completed, the sooner the design can be tested under production conditions and the smaller that design loop, the shorter the time-to-market.

Today's complex prototyping requires higher circuit density than ever before, and that includes multilayer boards. A multilayer board allows for a much more compact layout because circuits can be routed on hidden layers within the substrate itself.

A typical multilayer circuit board consists of various layers of the following three items:

- A base material (or substrate), such as FR4 or alumina, which supports the circuit.
- Copper (or other conductor) layers, where the circuits are structured.
- Prepreg, an insulative layer sandwiched between layers of copper.

These layers must be bonded properly to assure that no air or other impurities can contaminate or otherwise damage the interior of the circuit.

The final key to a successful multilayer board is a consistent, high-quality method of creating through-hole continuity that is complementary to the multilayer process.

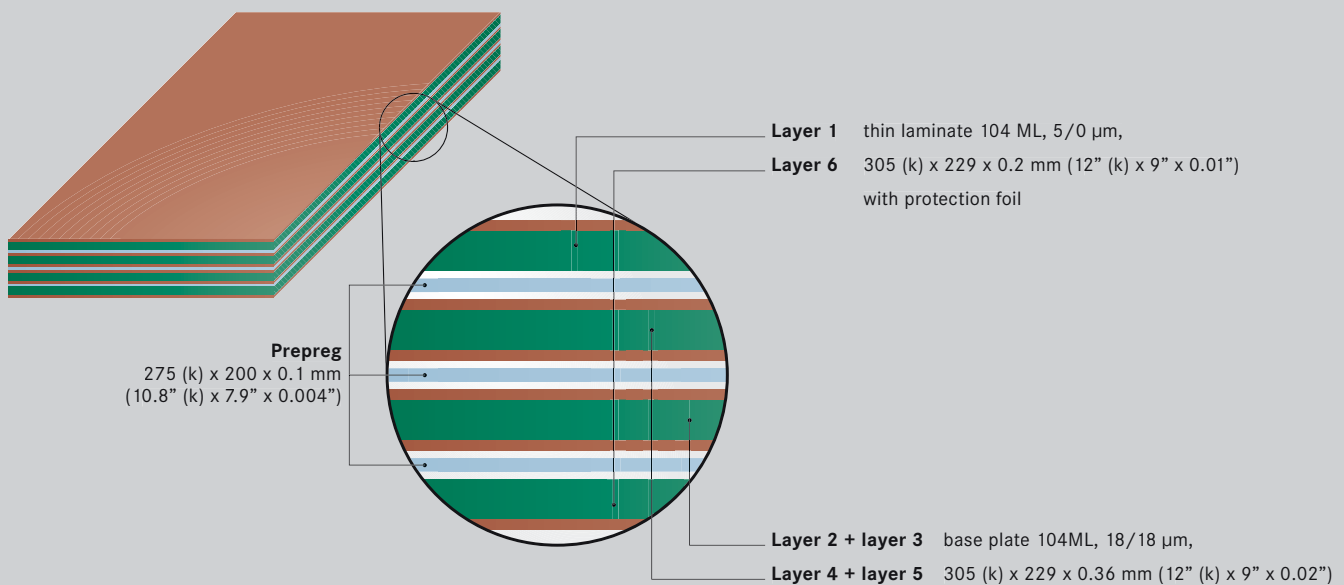

LPKF MultiPress II

Bench-top pneumatic press for multilayer PCBs

Item	LPKF MultiPress II
Part #	106328
Order info	Inside front cover



The LPKF MultiPress II is a bench-top pneumatic press, ideal for creating multilayer circuit boards in a laboratory or prototyping environment. The MultiPress II is ideal when speed, security, or convenience are key factors in the creation of custom or prototype printed circuit boards and is an indispensable tool in any rapid PCB prototyping situation.

- **Multilayer PCB prototypes and production boards in-house**
- **Easy-to-use interface allows four preprogrammed profiles**
- **Processes a variety of substrates**
- **Creates up to six-layer printed circuit boards**

MultiPress II

Plotters

Laser

Plating

Multilayer

SMT/Finishing

Tech Guide

Index

Bringing Multilayer Prototyping In-House

Rapid PCB prototyping achieves a new level of utility with the LPKF MultiPress II. When combined with a ProtoMat circuit board plotter (such as the ProtoMat S62) and a through-hole conductivity solution (such as the ProConduct® or MiniContac systems), the MultiPress II provides the final key to producing complex multilayered printed circuit board prototypes in a fraction of the time of an outside vendor and with absolute security of all data – perfect for today’s extreme time-to-market needs.

Small Footprint

The MultiPress II enjoys a remarkably small footprint for a 15 ton press. It measures only 530 x 480 mm (21” x 19”), which makes it ideal for small spaces in R&D and prototyping laboratories. LPKF also provides an optional table specially designed for the MultiPress II, or it can be placed on any surface certified to support at least 210 kg (463 lbs.).

Programmable Profiles

Four different heating/pressing/cooling profiles can be programmed into the MultiPress II’s microprocessor-controlled system, allowing for total customization of the process from start to finish.



Plotters

Laser

Plating

Multilayer

SMT/Finishing

Tech Guide

Index

Accessories



Accessories



Mobile table

LPKF also provides an optional table specially designed for the MultiPress II.

Part # **107050**



Compressor

The MultiPress II requires a source of compressed air. LPKF compressors provide clean, dry and reliable compressed air.

Part # **104863**

Specification table

LPKF MultiPress II	
Part #	106328
Maximum circuit board size (recommended)	305 x 254 mm (12” x 10”)
Maximum press area (gross)	420 x 360 mm (16.5” x 14.1”)
Maximum pressure	150 kN (15 tons)
Maximum temperature	210 °C (410 °F)
Compressed air supply	6–10 bar (87–145 psi), 30 l/minute (1 ft ³ /minute)
Maximum number of layers	6
Pressing time	Approx. 90 min*
Dimensions (W/H/D)	530 x 600 x 480 mm (20.9” x 23.6” x 18.9”) (desk top model)
Weight	210 kg (463 lbs.)
Power supply	230V/50–60 Hz, 2.0 kW
Microprocessor controlled	4 pressure/temperature/time profiles
Base materials	FR4, others upon request
* depending upon Prepeg	
Specifications subject to change.	

Special notes for multilayer board production

The LPKF MultiPress II is an ideal solution for the rapid development of boards as complex as six layers. Using the various time, temperature, and pressure profiles permits a great deal of flexibility when assembling and bonding the layers for a multilayer prototype.

Building from the center, the MultiPress II bonds all layers of the prototype simultaneously, creating a prototype the quality of which is indistinguishable from any production board – in a fraction of the time an exterior board house would require.

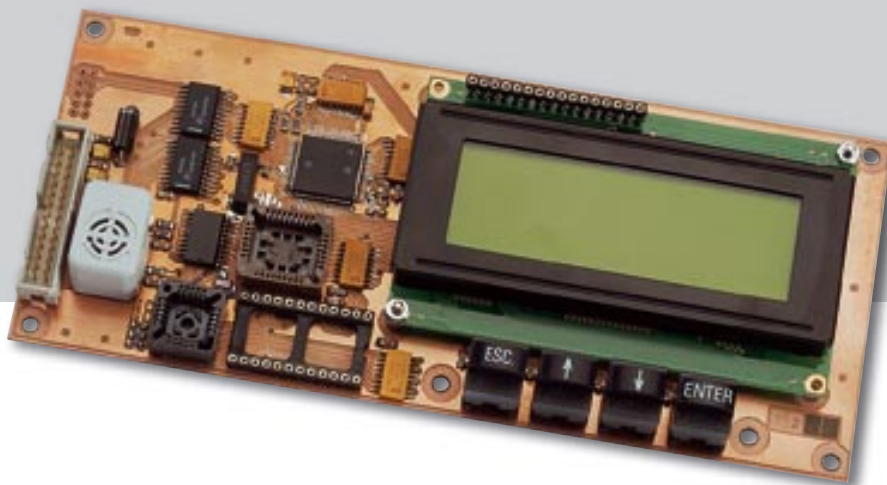

“The LPKF MultiPress is a programmable heat press that is compact, and cost effective. Making multilayer boards with this press is fast and easy.”

Ben Bark
Procyon PCB, Inc., USA



Introduction to SMT prototyping

Contents

LPKF ProMask 67
 In-house production of solder-resist masks

LPKF ZelPrint LT300 71
 SMT solder paste printer

LPKF ProtoPlace 75
 Pick & Place assembly system

LPKF ProtoFlow 79
 Lead-free reflow oven ideal for in-house rapid PCB prototyping

Review 81

Plotters

Laser

Plating

Multilayer

SMT/Finishing

Tech Guide

Index

Although accuracy and precision is vital, the real key to a well-functioning SMT prototyping solution is a tightly integrated suite of tools.



The circuit board must be milled, routed and through-plated, using a tool such as the ProtoMat S100 and Contac III. This creates the printed circuit board on the substrate.



An insulative mask must be applied to the board, to avoid shorts and corrosion during the remaining steps and after production.

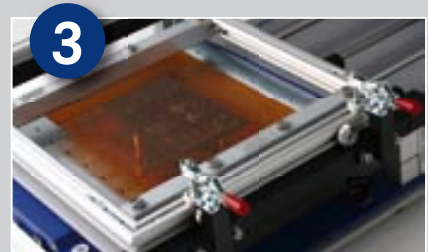

Solder paste must be applied where components will be placed. Application of solder paste is a precision operation.

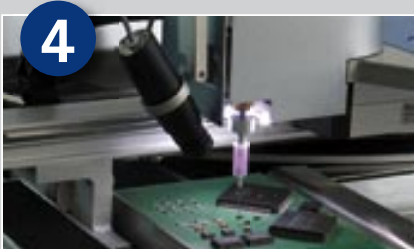

The printed circuit board must be populated. All components must be placed precisely and because SMD components are so small, this must usually be performed using a semi-automated placement system such as the LPKF ProtoPlace.



The final step in any SMT prototyping process is the reflow soldering process, where the populated printed circuit board is heated in a carefully regulated temperature profile sequence that melts the solder paste.

LPKF provides exactly these tools, perfect for SMT prototyping situations of any size and shape.

LPKF ProMask and ProLegend

In-house screenprinting and solder-resist masks

Item	LPKF ProMask
Part #	117072
Order info	Inside front cover



Plotters

Laser

Plating

Multilayer

SMT/Finishing

Tech Guide

Index

An easy-to-use cost-effective solution for producing professionally masked PCBs in an in-house prototyping environment. LPKF ProMask gives already milled prototype circuit boards the professional finish they deserve. The quick and simple process enables the soldering of SMD or conventional components with no fear of short circuits.

- **Compact, quick and easy to use**
- **Professional finish and perfect soldering**
- **Four simple steps to a professional result**

ProMask

Professional solder-resist masks for in-house prototyping

The LPKF ProMask is an easy-to-apply green solder-resist mask. This professional finish, ideal for all rapid PCB projects, is especially critical for SMT projects, where lines are very close and circuit isolation/insulation is a key component of the prototyping process. The ProMask system requires very little training and no prior experience to master.



A PCB from a small batch production showing the professional finish of LPKF ProMask

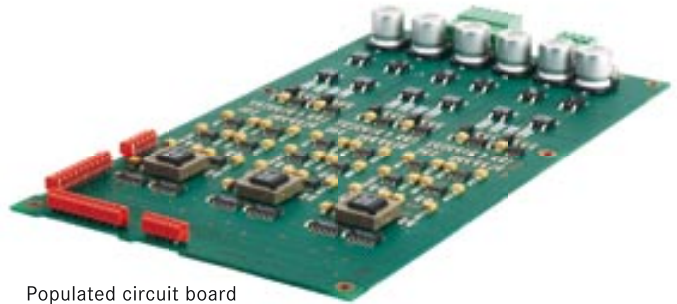

Populated circuit board with LPKF ProMask

Plotters

Laser

Plating

Multilayer

SMT/Finishing

Tech Guide

Index

Perfect results for in-house prototyping

The LPKF ProMask finishes prototype PCBs professionally and helps protect traces and prevent short circuits from soldering conventional through-hole or SMT components.

Easy to use

The LPKF ProMask includes all the necessary instructions, tools, and supplies. All consumables are premeasured and individually sealed.

Environmentally friendly

All remnants from the ProMask process are rendered environmentally harmless with an included Ph conditioning powder. Disposal is safe and simple.

Security and rapid turnaround time

In-house PCB prototyping moves circuits from design to prototype to market faster by eliminating production delays and high costs associated with outside vendors. Additionally, all designs remain securely within the organization.

LPKF ProMask Set

All the necessary parts are conveniently packed in a portable toolcase, perfect for field engineers. Each set includes:

Amount	Description
20	Solder resist
1	Developer dish
1	5 cm roller set with pan
20	Laser printed foil DIN A4
10	LPKF developer
10	LPKF conditioner
1	Cleaner
1	PCB cleaner
1	Foam roller
	Various accessories

Content subject to change.

Produce professional legend printing with LPKF ProLegend!



Produce professionally finished boards with LPKF's ProLegend, a simple-to-use method of adding screenprinting, logos, and circuit legends to any prototype PCB.



Apply the solder-resist mask in four simple steps

1 Producing the artwork

The artwork template is easily produced by printing it from LPKF CircuitCAM (version 5.0 or above) on a standard laser printer (for best results 600 or 1,200 dpi).



Printing the solder mask artwork

2 Applying the solder-resist lacquer

The lacquer is simply mixed using the single portion packets of lacquer and hardener. It is then applied to the finished prototype PCB using a disposable roller. After application the PCB is pre-dried for 10 minutes in the hot air oven.



Applying the solder-resist lacquer

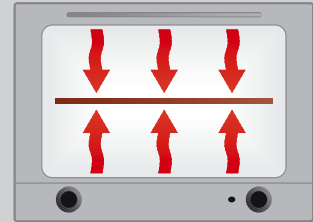

Pre-drying in a hot air oven

3 Exposing PCB with the artwork

The PCB is placed in the image exposure unit and the artwork is placed over it using registration marks. The exposure unit is switched on for 30 seconds after which the board is removed and the artwork film pulled off.



Positioning the artwork



Activating the image exposer

4 Developing and hardening the solder-resist mask

A bath of developer is prepared from the developer powder and hot water. The PCB is immersed in the bath and the non-exposed resist is removed by gently brushing. The lacquer residue is rinsed off under flowing water, then the resist is hardened for 30 minutes in the hot air oven after which the board can be cleaned with LPKF cleaner and rinsed with water.



Developing the solder-resist mask

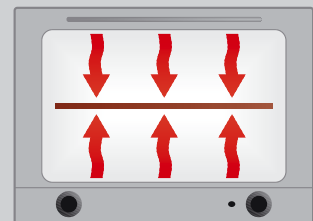

Hardening in a hot air oven



ProLegend's process is almost identical.

Please contact a sales representative for more information.

Accessories and consumables



Accessories



UV-Exposer

Transfer the artwork pattern to the PCB surface in approximately thirty seconds.

230/240 V: Part # **117050**
 110/120 V: Part # **117192**



Hot air oven

Pre-dry the PCB and harden the resist in thirty minutes using the hot air oven. The oven offers an integrated time switch clock and a precise temperature regulator.

Part # **115877**



Consumables

LPKF ProMask Consumables Set

Includes ProMask lacquer gel, developing foils, and developer.

Part # **117108**

Specification table

LPKF ProMask	
Part #	117072
Maximum base material dimensions	229 x 305 mm (9" x 12")
Maximum working area of image exposer	240 x 340 mm (9.5" x 13")
Base material types	FR4, FR3, RO3000®, RO4000®, TMM® *
Processing time	Approx. 60 min
Pad separation	≥0.5 mm (20 mil) fine pitch
Adhesion strength	Class H and T, testing method: IPC-SM-840 C, Subsection 3.5.2.1
Solder bath resistance	20 sec at 265 °C (509 °F), testing method: IPC-SM-840 C, Subsection 3.7.2 10 sec at 288 °C (550 °F), testing method: MIL-P 55 110 D 20 sec at 288 °C (550 °F), testing method: UL 94 (lead-free)
Surface resistance	20 kΩ, testing method: VDE 0303, Section 30, DIN IEC 93
Moisture resistance and isolation resistance	Class H and T, testing method: IPC-SM-840 C, Subsection 3.9.1
Solvent/Cleaning agent stability	IPC-SM-840 C (10% caustic cleaner, isopropyl alcohol, monoethanolamine)
Minimum capital height	2.0 mm (with 1,200 dpi laser printer)
Minimum capital strength	0.1 mm (with 1,200 dpi laser printer)
Hardware requirements	600 (or higher) dpi laser printer
Software requirements	CircuitCAM 5.1 or higher

* Further materials upon request.
 Specifications subject to change.

LPKF ZelPrint LT300

SMT solder paste printer

Item	LPKF ZelPrint LT300
Part #	107356
Order info	Inside front cover

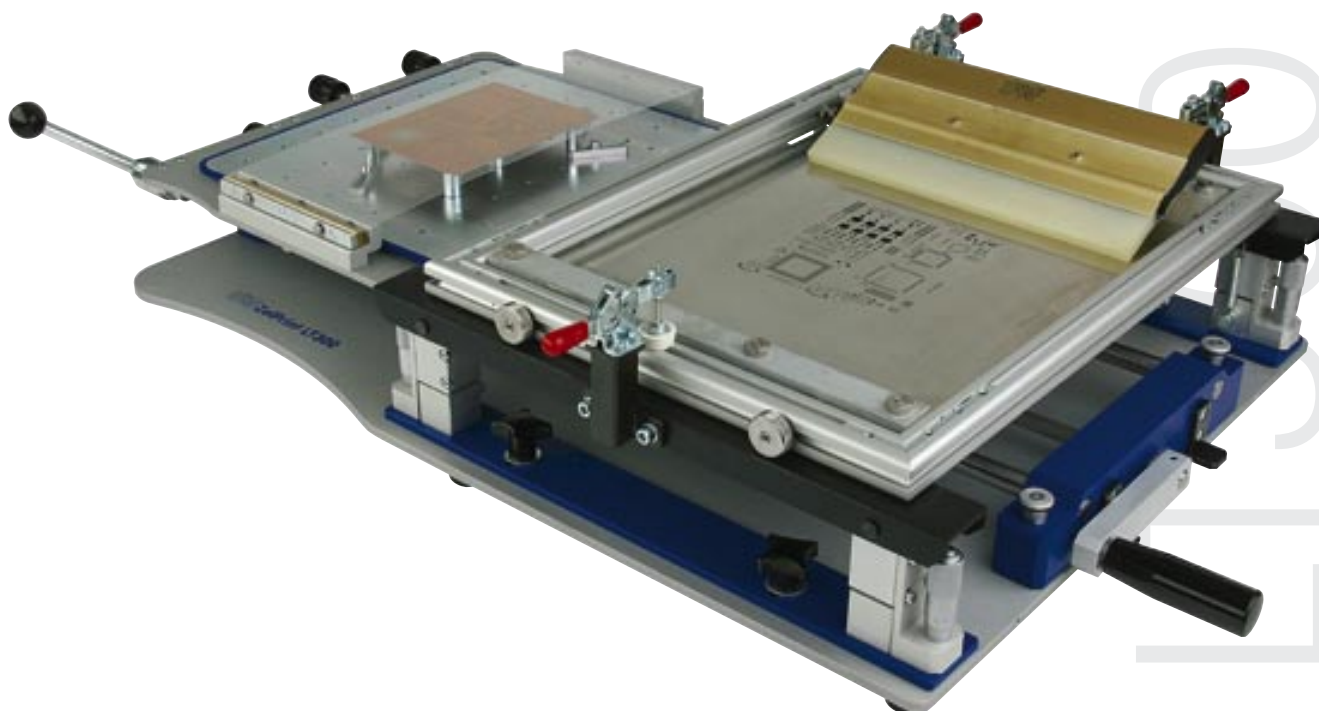

The LPKF ZelPrint LT300 is a precision manual stencil printer. This tabletop model can be used for prototypes and for small batches of fine pitch SMT boards. On-contact fine-pitch printing, precise vertical separation between stencil and PCB, and slow snap-off provides superb printing results. This unique solution allows printing of 0.3 mm (12 mil) pitch (ultra-fine-pitch area).

The LPKF ZelPrint LT300 boasts high positioning accuracy, simple operation and the ability to use milled polymer stencils (limited to 0.65 mm [25 mil] pitch), reducing costs and increasing efficiency in the production of circuit board prototypes.

This printer is shipped with a ZelFlex quick-release stretching frame for stencils, but is also compatible with various other frames.

- On-contact fine-pitch printing
- Parallel stencil separation
- Printing populated double-sided boards
- Compatible with various stencil frames
- Test print screen included
- Screen printing
- Optional vacuum table for printing on flex and rigid PCBs

Plotters

Laser

Plating

Multilayer

SMT/Finishing

Tech Guide

Index

Fine pitch printing

Precise three-dimensional (X, Y, theta and clearance) adjustment of the PCB and the stencil with micrometer screws is vital for superior printing results. Excellent positioning accuracy and a specially designed lever for speed controlled parallel separation makes ultra-fine-pitch printing possible. Micrometer screws easily and precisely adjust the PCB-screen gap.

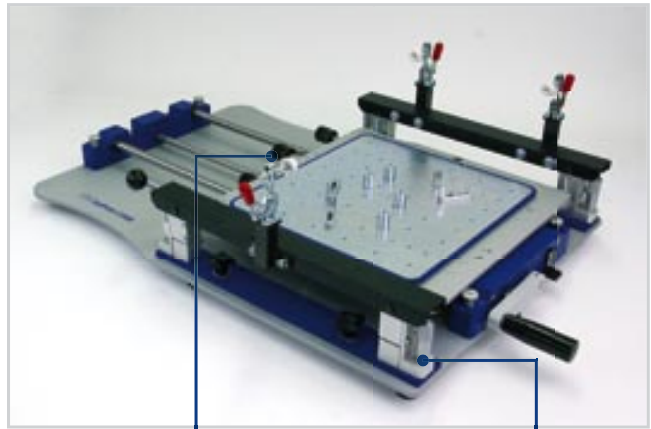

Micrometer screws

PCB clamping

The LPKF ZelPrint LT300 features freely adjustable, high-clearance PCB nesting pins that allow boards populated on one side to be printed on the other. Frames, such as the LPKF ZelFlex, easily mount on adjustable supports and clamp with height and length adjustable fixing clamps. The LPKF ZelPrint LT300 includes a test print screen for fast set-up of new print jobs.

Fixing clamps



PCB nesting pins



Test print screen

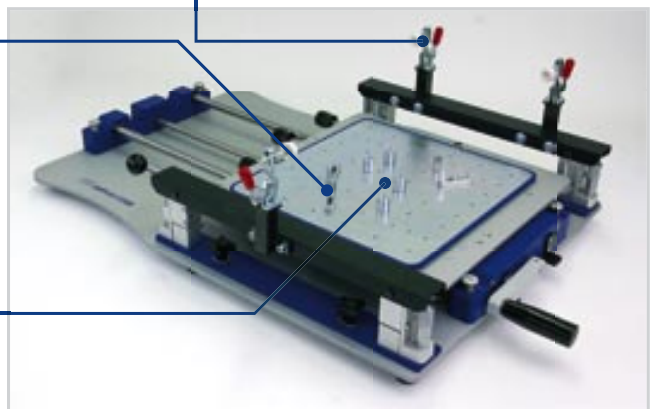

Plastic stencil for rapid PCB prototyping

The ability to use milled polymer stencils (limited to 0.625 mm/25 mil pitch) reduces costs and increases efficiency in the production of circuit board prototypes.

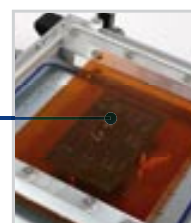

Options

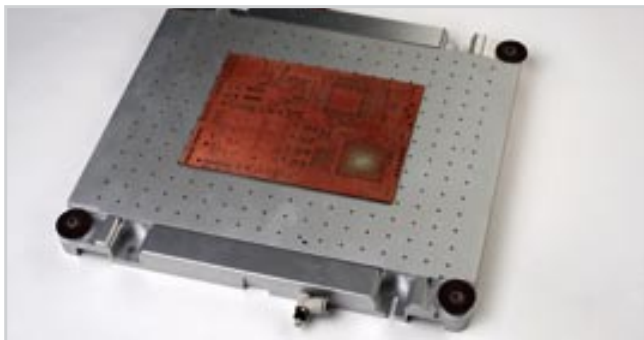

Vacuum table

Vacuum table for printing on flex and rigid PCBs as well as for fast clamping of rigid PCBs is available as an option. Flex and rigid boards can be easily moved to the LPKF ProtoPlace together with a vacuum table as 100% compatibility is ensured. The table can be easily and freely moved from one device to another without disconnection or interruption of vacuum.

Part # **119684**

Accessories



Accessories

ZelFlex Frames for LPKF ZelPrint LT300

Mechanical stretching frame

Insert plastic or metal stencils into double-sided LPKF ZelFlex ZR frames. The fast exchange and patented stretching system optimizes tensioning and easy handling.

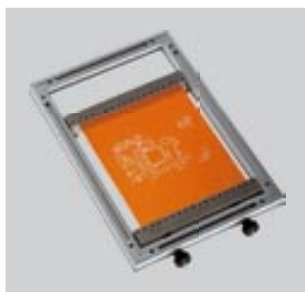

ZelFlex ZR 362x480*	
Part #	101321
Type	2-sided mechanical
Print area	260 x 330 mm (10.2" x 13")
Foil size	Up to 310 x 410 mm (12.2" x 16.1")
Squeegee max.	280 mm (11")

* Included in delivery Specifications subject to change.

Pneumatic stretching frame

Professional quick-release stencil frame with pneumatic 4-side action: Ideal for high-volume environments. Frame maintains tension even after air is disconnected.



ZelFlex Z4P 406x508	
Part #	115629
Type	4-sided pneumatic
Print area	286 x 388 mm (11.3" x 15.3")
Foil size	368 x 470 mm (14.5" x 18.5")
Squeegee max.	290 mm (11.4")

Specifications subject to change.

Squeegees

LPKF offers different types of squeegees for the application of solder paste.

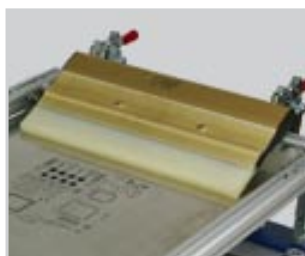

Squeegees		
Part #	Type	Size
101330	Rubber	250 mm (9.8")
101331	Rubber	350 mm (13.8")
101325	Hand squeegee, rubber	150 mm (5.9")
108140	Hand squeegee, rubber	260 mm (10.2")

Specifications subject to change.

Test print frame TR350

Part # **106957**

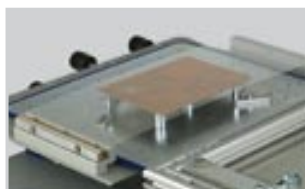

Specification table

LPKF ZelPrint LT300	
Part #	107356
Frame dimensions	Width up to 430 mm (16.92") Length adjustable from 420 to 520 mm (16.54" to 20.47") Height adjustable from 20 to 40 mm (0.78" to 1.57")
Maximum printing area	300 x 300 mm (11.8" x 11.8")
Print stroke	Manual
Print table adjustment	X and Y ±10 mm (0.4"/400 mil), θ±5°
Max. PCB thickness	5 mm (0.2"), optionally more
Squeegee type	Rubber (optionally metal)
Accuracy (machine)	±0.025mm (±1 mil)
Print weight	±0.04 mm (±1.57 mil)
Double-side printing	Max. height of components 15 mm (0.59")
Dimensions (W/H/D)	740 x 180 x 530 mm (29.1" x 7.1" x 20.9")
Weight	30 kg (66 lb)
Ambient conditions	Temperature: 20–35 °C Humidity: 30–95%
Specifications subject to change.	

- Plotters
- Laser
- Plating
- Multilayer
- SMT/Finishing
- Tech Guide
- Index

LPKF ProtoPlace

Pick & Place assembly system

Item	LPKF ProtoPlace
Part #	114459
Order info	Inside front cover



The LPKF ProtoPlace is an ergonomically designed, semi-automatic pick & place system for the professional assembly of SMD printed circuit board prototypes and small batch projects. The ProtoPlace quickly assembles SMT boards, with the user controlling each step of the assembly process through an LCD display. Most functions are easily executed from an interface panel with four directional arrows.

A camera system coupled with the monitor ensures easy and accurate component positioning control, so the ProtoPlace can precisely assemble complex circuits.

Manually guided movements of the ProtoPlace manipulator can be locked in both the X- and Y-directions, and fine adjustments can be performed using micrometer screws. A pneumatic device supports the positioning of the components, eliminating errors and guaranteeing accuracy.

Three different feeders supply the components. An integrated dispenser for solder paste is standard equipment.

- **Precise fine-pitch component assembly**
- **Pneumatic component placement**
- **Integrated multifunctional solder paste dispenser**
- **Optional camera system aids component positioning**
- **Optional motorized turntable**
- **Microprocessor-controlled electronics**

Plotters

Laser

Plating

Multilayer

SMT/Finishing

Tech Guide

Index

The LPKF ProtoPlace features:



Micro-table

The micro-table clamps printed circuit boards as large as 297 x 420 mm (11.8" x 16.5"). A fine-adjustment capability and X- and Y-axis lockdowns make the ProtoPlace ideal for the placement of complex components.



Manipulator

The manipulator picks & places components, and applies paste, glues and washers. The manipulator easily reaches every feeder (stick and tape feeders, turntable, or palette) by using vacuum and a picking needle. An additional manual control rotates components where needed and automatically places components.

And many more, such as:

Multifunctional dispenser

This external unit dispenses soldering paste, glues, and washers from its mount directly on the manipulator. It also enables dispensing of low viscosity media.

Air regulator

The air regulator regulates pressure during dispensing, vacuum during placement, and vacuum during dispensing.

Foot switch

The integrated foot switch provides additional hands-free mode control to the user.

Plotters

Laser

Plating

Multilayer

SMT/Finishing

Tech Guide

Index



Keyboard

The integrated multifunctional keyboard allows the direct selection of options, fine control of adjustments, and setting precise individual parameters.

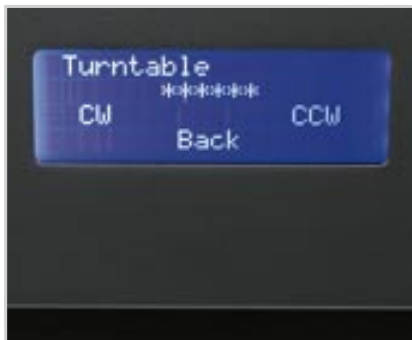

LCD display

Control and monitor the process via the 4-line LCD display. All functions and parameters can be easily selected and displayed on the four-lined LCD display, while directing the operator to the next step.

Options

Vacuum table

Vacuum table for placement of components on flex or rigid PCBs.

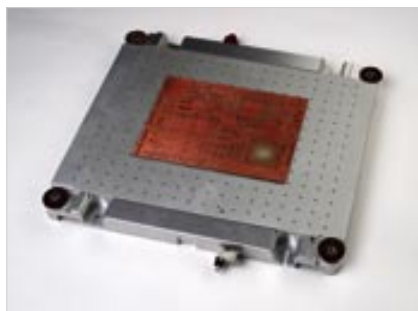

Part # **119684**

Accessories



Accessories



Motorized turntable

The optional motorized turntable stores individual components in bins, and permits a significantly accelerated picking process. The bins can be labelled with type, value and sign.

45 component bins: Part # **114460**

75 component bins: Part # **114461**

90 component bins: Part # **114462**



Feeder carrier

Place up to thirteen different component feeders into the optional feeder carrier. The feeder carrier is necessary if additional tape feeder or stick feeders are required.

Part # **115590**



Tape feeders

The LPKF ProtoPlace uses tape feeders serving 8 mm, 12 mm, and 16 mm components.

Tape feeder 8 mm: Part # **116004**

Tape feeder 12 mm: Part # **116008**

Tape feeder 16 mm: Part # **116009**



Stick feeders

The LPKF ProtoPlace supports stick feeders serving different components.

S08-S028: Part # **101356**

S08L-S028L: Part # **101356**

PLCC28-PLCC44: Part # **101357**

PLCC52-PLCC84: Part # **103897**



Micro camera

The micro camera mounts directly on the manipulator and feeds a video signal of the process to the optional monitor. This increases control and accuracy when placing fine-pitch components.

Part # **115040**



Color LCD monitor

The optional LCD monitor, in tandem with the optional micro camera, allows the user to track and control small parts placement very precisely.

Part # **119777**



Compressor

It features extra quiet operation (52 dB), a 6-l container, and produces 6 bar and an output of 50 l/min.

Part # **101092**

Specification table

LPKF ProtoPlace	
Part #	114459
Maximum PCB size	400 x 300 mm (15.7" x 11.8")
Minimum size of components	0201 chip components
Pulse/pause duration	0.1–9 sec/0.1–2 sec
Number of dosing points	Up to 300 per minute
Dosing quantity	Min. 0.2 µliters
Turntable position	Left and/or back
Feeders position	Left
Operating air pressure	0.1–4 bar (1.4–58 psi)
Vacuum	Max. 0.8 bar (11.6 psi)
Weight	25–35 kg (55–77 lbs) depending on accessories
Dimensions (W/H/D) (w/ all feeders and turntable)	1,000 x 500 x 900 mm (40" x 10" x 35")
Dimensions (W/H/D) (bare machine)	760 x 250 x 760 mm (30" x 10" x 30")
Ambient operating conditions	Temperature: 5–35 °C, (41–95 °F) Humidity: 30–95%
Compressed air supply	6 bar (87 psi), min. 10 l/min (0.35 cfm), oil free, water free
Power supply	120/240 V, 50–60 Hz, 10 W
Specifications subject to change.	

Plotters

Laser

Plating

Multilayer

SMT/Finishing

Tech Guide

Index

LPKF ProtoFlow

Lead-free reflow oven ideal for rapid PCB prototyping

Item	LPKF ProtoFlow
Part #	117609
Order info	Inside front cover



Motorized drawer

User-friendly menu navigation

The ProtoFlow is LPKF's premiere convection oven, ideal for lead-free reflow soldering. A host of features and accessories make it one of the most useful components in any rapid PCB prototyping environment.

The LPKF ProtoFlow is a key component in rapid SMD prototyping and small batch production. Compact and versatile, it offers a large working area with motorized drawer for automatic cool-down and easy access, and microprocessor-controlled temperature/time profiles. The LPKF ProtoFlow is excellent for SMD reflow soldering, and hardening of conductive polymer for plated through-holes, and other thermal procedures.

The LPKF ProtoFlow can be fitted with a digital flow meter for inert gas to prevent oxidation during the reflow process, assuring optimal results of soldered joints.

- **Lead-free reflow process**
- **User-friendly LCD display with keyboard ensures easy operation**
- **Preprogrammed with industry standard profiles**
- **Integrated USB port for easy programming of reflow profiles and process recording and analysis**
- **Motorized drawer for easy access and automatic cool-down after reflow process**
- **Inert gas option prevents oxidation during process**
- **Four optional temperature sensors**

Plotters

Laser

Plating

Multilayer

SMT/Finishing

Tech Guide

Index

Guaranteed sophisticated PCB prototyping in the lab

User-friendly LCD display

The LCD display allows for extremely easy data setting. All profile parameters such as temperature, process duration, and cooling airflow can be individually programmed and stored as custom profiles.

Lighted process chamber

Observe the process through the ProtoFlow's window. Integrated interior lighting reveals the status of the soldering process and allows for on-the-fly job modification where needed to optimize the reflow process.

Motorized drawer

The LPKF ProtoFlow is equipped with a motorized drawer which allows easy access to the circuit board. The drawer opens automatically, starting the cool down phase.

Applications

The LPKF ProtoFlow is ideal for SMD reflow soldering, curing of adhesives and conductive polymer, and other thermal procedures.



Soldered PCB prototype

Options

Inert gas option

External connection with digital flow meter for inert gas is available for LPKF ProtoFlow. Nitrogen atmosphere significantly decreases the oxidation during process and ensures better results of soldered joints.

Part # **117817**

Temperature sensors

The LPKF ProtoFlow can be fitted with four optional thermocouple probes, which can be mounted anywhere on the PCB or components, allowing a complete real time data logging of temperature profiles and instant feedback to the user. This data can be stored on a PC and analysed later.

Part # **117850**

Specification table

LPKF ProtoFlow	
Art.-Nr.	117609
Max. circuit board size	230 x 305 mm (9" x 12")
Preheating temperature/time	220 °C (428 °F), 999 sec
Max. reflow temperature/time	320 °C (608 °F), 600 sec
Long thermal treatment temperature/time	220 °C (428 °F), 64 h
Temperature stabilization time	<5 min
PCB cooling	Double, speed-adjustable bottom-mounted fan
Power connection	230 V, 50-60 Hz, single phase
Max. power consumption	3.2 kW
Dimensions (W/H/D)	647 x 315 x 450 mm (25.5" x 12.4" x 17.7")
Weight	22 kg (48.5 lbs)
Operation ambient conditions	Temperature: 15-30 °C, Humidity: 30-80%

Specifications subject to change.

Review of rapid PCB prototyping for SMT circuitry

LPKF Laser & Electronics provides this complete suite of tools for the creation of in-house PCB prototyping of SMT components.



The LPKF ProtoMat S100, an excellent high-speed circuit board plotter can produce PCB prototypes in a matter of minutes.



The LPKF ProConduct® through-hole conductivity system is ideal for many in-house rapid PCB prototyping Environments, for low volume production, labs or shops where chemical electroplating is impractical.



The LPKF MultiPress II is a bench-top pneumatic press, ideal for creating multilayer circuit boards in a laboratory or prototyping environment.



The LPKF ProMask provides the ability to cover PCB traces with a solder resistant green mask, protecting traces during the remaining process and beyond into production.

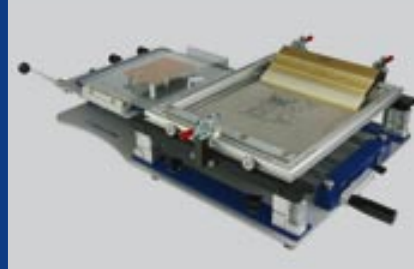

The LPKF ZelPrint LT300, a manual fine-pitch stencil printer, places solder paste in exact amounts and locations on a prototype PCB.



The LPKF ProtoPlace desktop pick & place machine uses a precision manipulator to set SMT components (manually or automated) onto a PCB prototype, from small chips to large QFPs.



The LPKF ProtoFlow is a microprocessor-controlled lead-free reflow oven. Featuring a large working area, and controlled temperature, it is perfect for the final step of producing an SMT rapid prototype.



Create SMT prototypes in the laboratory in a fraction of the time of using an external vendor. Complete multiple product life cycles in a single day, reducing dramatically the critical time-to-market, using LPKF's integrated suite of rapid PCB tools.

Plotters

Laser

Plating

Multilayer

SMT/Finishing

Tech Guide

Index

Our customers are our best salesmen!

Working in development presents several problems when prototyping circuits.

In our situation developing a prototype circuit card is usually an on demand situation (spur of the moment) that at times we would have to complete by utilizing wire wrap, or bread boarding from a schematic.

Most of the time being a long and drawn out project with sometimes mixed results, and depending on the size of the circuit, a pain to rework.

In this situation utilizing our ProtoMat H100 system we can produce a more reliable circuit card that is easily reproducible in a matter of hours instead of days with minimal user input once the process is started, and easily support our on demand style work atmosphere.

**Thanks,
Michael**

Michael S. Baranowski
Technical Specialist
General Dynamics Land Systems
USA

The LPKF ProtoMat is small and easy to use. It is very useful to make all kinds of small-series PCBs. And it corresponds fast to design changes!

DENSO CORPORATION, Development Division
Mr. Tomokazu Watanabe
Japan

We are a small research and development lab, so the purchase of our S62 demanded a large commitment from our operational budget. However the results have been all I could have asked for; we have total control of project scheduling. Depending on the scale our engineer can design, test and re-implement a board in 2-3 days, where before he would be at the mercy of the priorities of an outsource. Having an in-house PC Board plotter has allowed us to focus on design problems rather than the 'hurry up and wait' problems of scheduling issues.

Greg Ford
Gregory Industrial Computer Ltd.
USA

Being a small company, sales is always pressuring us to get out new products. With the ProtoMat M60, we are literally able to prototype our design the very next day. This better enables us to meet our deadlines, keep the sales' folk happy and most importantly satisfy our customers. It is a great machine and so is the customers service!

Shane De Lima, R&D Engineer
The Bodine Company
Collierville
USA

Higher educational research often demands repeated creation of new and improved prototypes. The Institute of Biomedical Engineering at the University of New Brunswick, Fredericton, N.B., Canada, has a long history in the research and clinical aspects of advanced myoelectric controls systems for artificial limbs, and it's recognized worldwide for this work.

"The design and fabrication of prototypes is a key element of much of this research, and it is here that we utilize the ProtoMat S62", says chief technologist John Hayden. He looked to the S62 because of the increasing demands placed on board production by surface-mount components. He also indicated that some designs were using the minimum isolation width to keep board size to a minimum.

Research that uses RF layout for wireless bio sensors will be one of the projects tackled in the near future.

John Hayden
Institute of Biomedical Engineering
University of New Brunswick
USA

You can't beat the performance of an LPKF system for RF & Microwave prototyping. We do even up to three iterations of design within a day.

Leonard Weber
Agilent
Santa Rosa, CA
USA

Don't miss out other technical solutions from LPKF

LPKF offers more than only rapid PCB prototyping in-house systems. We are proud to offer the following laser-based machines for the production of stencils, for the production of printed circuit boards, 3D-MID solutions and laser plastic welding.

Stencil production with LPKF Stencil Lasers and LPKF Quality Inspection Systems

LPKF is a worldwide leader in Stencil Lasers, offering leading technology for the production of SMT solder paste stencils. LPKF Stencil Lasers are accurate and reliable.

LPKF offers a variety of machines to suit any stencil laser application.

LPKF MicroCut



LPKF ScanCheck MicroView



Applications



EL stencil



Waferbump



Metal stencil



Precision cut metal components

The LPKF MicroLine series laser systems cut flexible or rigid circuit boards easily, as well as cover layers.

Today's electronic device market requires tighter tolerances and faster turnaround. The LPKF MicroLine laser systems integrate the latest laser technology into these future production requirements, meeting the highest technological expectations for cover layer and body cutting/depaneling for flexible, rigid-flex or rigid printed circuit board production.

LPKF MicroLine UV laser systems for laser cutting of flex circuits and cover layers



LPKF MicroLine 600D



LPKF MicroLine 350D



LPKF MicroLine 350Di

LPKF MicroLine CO₂ laser system for laser depaneling of rigid circuit boards.



LPKF MicroLine 350Ci

Laser system for the production of 3D molded interconnected devices (MIDs).



LPKF MicroLine 3D

Applications



Flex circuit board

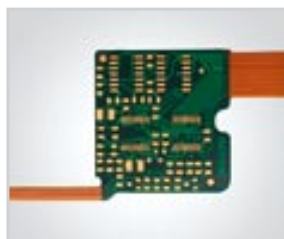

Rigid-flex circuit board

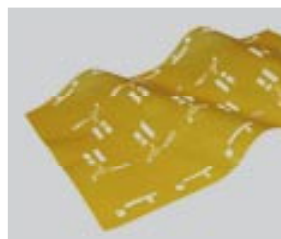

Cover layer



3D-MID

Professional circuit board repair using the LPKF LaserScalpel

The LPKF LaserScalpel is the first laser-based solution to eliminate short circuits on finely-structured PCBs, and is able to visualize and remove errors as small as a few micrometers.

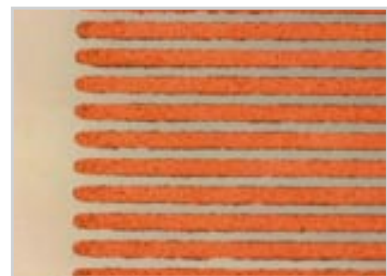
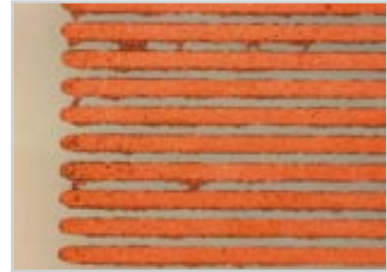

50 µm circuitry before and after repair

LPKF laser plastics welding

Laser plastics welding offers many technological as well as economic advantages over conventional welding procedures. The Plastics Welding Division of LPKF Laser & Electronics AG is one of the first business ventures in the world to exclusively concentrate on this innovative technology, offering simple economic solutions for any set of requirements.

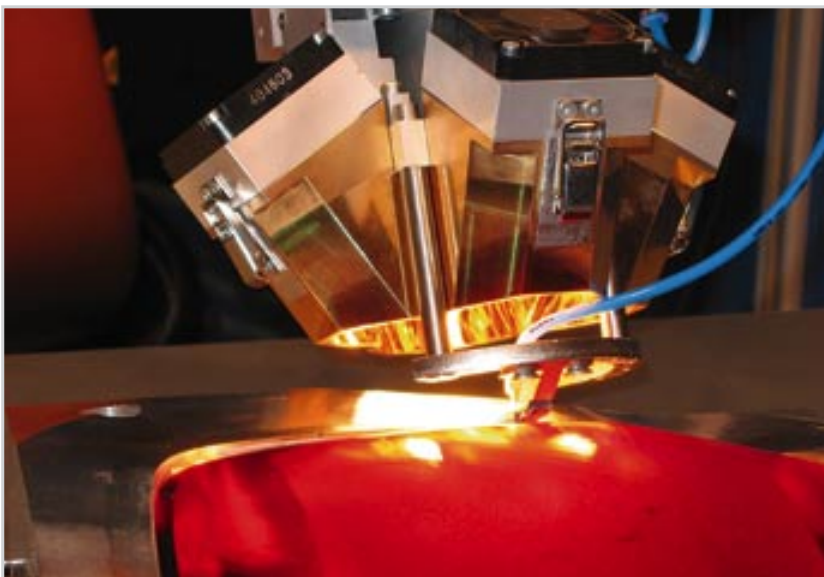

For more information please contact:

LPKF Laser & Electronics AG
Plastic Welding Division
Gundstraße 15
D-91056 Erlangen
Germany

Phone +49-(0)9131-61657-10
Fax +49-(0)9131-61657-77
E-mail info@laserquipment.de
Web www.laserquipment.de

LPKF's comprehensive job shop serves the needs of the laser micromachining industry

LaserMicronics GmbH in Garbsen, Germany, offers a comprehensive job shop, focusing on micromachining and material processing by industrial lasers.

LaserMicronics enjoys full access to LPKF's laser and other top-of-the-line prototyping systems, and is capable of both small batches and high volume production (in close cooperation with LPKF System customers).



For more information please contact:

LaserMicronics GmbH
Osteriede 7
Gundstraße 15
D-30827 Garbsen
Germany

Phone +49-(0)5131-7095-0
Fax +49-(0)5131-7095-90
E-mail info@lasermicronics.de
Web www.lasermicronics.de

Innovation motion control, precision drive technology, portal and measuring systems

LPKF Motion & Control GmbH, a subsidiary of LPKF Laser & Electronics, develops and manufactures innovative drive and motion control technology, providing products such as precision drives, granite based air-guided systems with linear or spindle drives, highly mobile single and multi-dimensional linear induction motors, position measuring systems and interpolators, 3D measuring systems and modern control systems and servo controls.



For more information please contact:

LPKF Motion & Control GmbH
Mittelbergstraße 17
D-98527 Suhl
Germany

Phone +49-(0)3681-8924-0
Fax +49-(0)3681-8924-44
Email info@lpkf-mc.de
Web www.lpkf-mc.de



Technical Guide

Introduction

Contents

Plotters	Base material, an overview	89
	Application review and compatibility grid	90
Laser	CAM Software, LPKF CircuitCAM	92
	Machine control software, LPKF BoardMaster	93
Plating	Building a basic 2-sided PCB prototype, step-by-step	94
	Chemical free through-hole plating, step-by-step	95
Multilayer	Galvanic through-hole plating, step-by-step	96
	A 6-layer multilayer PCB, step-by-step . . .	97
SMT/Finishing	LPKF ProMask professional solder mask, step-by-step	98
	Surface Mount Technology (SMT), step-by-step	99
Tech Guide	Microwave and RF application notes	100
	Plastic and aluminum engraving	101
Index	Glossary	102
	Index	106

The following Technical Guide provides a brief overview of several technologies and applications, from PCB design to finished production, including special application notes, illustrations, photographs, or other references, as well as useful tips and tricks from the LPKF support staff.

LPKF rapid prototyping tools represent the state-of-the-art in rapid PCB prototyping. Single layer, double layer, multilayer boards; through-hole plating or surface mount material – LPKF has a tool for every application.

In all instances, LPKF strongly recommends carefully reviewing the User Manual for every product before starting any project. Although this section contains useful overviews, nothing beats practice to get the most out of tools as powerful and versatile as LPKF’s rapid PCB prototyping equipment and products.

Technical Guide

Base material, an overview

The first and most critical component to any high quality printed circuit board is the base material. This consists of some kind of substrate and one or two layers of conductor.

Substrates

Substrates for printed circuit boards are manufactured from a wide variety of materials, but the most popular is FR4, which is an epoxy laminate, reinforced with glass fibers. Most printed circuit boards will be FR4 and this substrate can range in thickness from 0.25 mm (10 mils) to 3.125 mm (125 mils), although most applications use 0.74 mm (29 mils) or 1.5 mm (59 mils).

For higher frequency work, such as microwave and RF boards, a popular substrate is RO4000®, which is also an epoxy laminate with glass fiber reinforcement, but RO4000® also includes small ceramic particles. Because the substrate itself becomes part of the circuit in a microwave or RF component, it's critical that tighter tolerances are met, so materials such as RO4000® are designed with better dielectric and loss tangent characteristics.

Conductors

By far the most common conductor in the industry is copper. Copper is laminated onto nearly every possible substrate. The amount of copper laminate is usually measured in ounces or microns. If measured in microns, it is a direct measurement of the thickness of the copper. If measured in ounces, the measurement refers to how many ounces of copper in one square foot. The most common copper weight sold in the US is 1 ounce (34 micron).

When electroplating, copper is added to the PCB, so when electroplating is the expected method of producing through-hole conductivity, LPKF recommends starting off with a thinner conductor surface, such as 9 µm (1/4 oz) or 5 µm (1/8 oz).

Occasionally, copper conductor is coated with an additional metal, such as nickel, tin, or gold.

TMM® class substrates are also epoxy laminates with ceramic particles, but there is no glass fiber content. TMM® materials exhibit even tighter tolerances for microwave and RF work.

PTFE substrates are currently the industry standard for microwave and RF work, offering superior electrical and mechanical characteristics.

Flexible substrates are polyimide films used as substrates. These substrates are, as expected, quite flexible and are useful in applications where flexibility is required, such as moving armatures and flexible sensor suites.

Flex-rigid substrates are polyimide substrates that have been bonded to short sections of rigid FR4 material. This basically permits a connection between two rigid circuit boards.

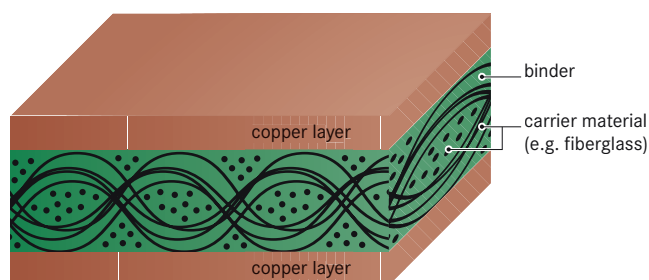
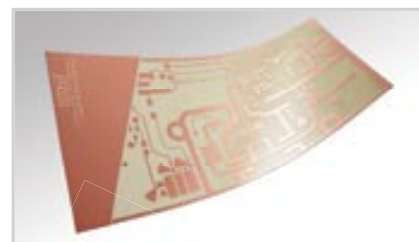
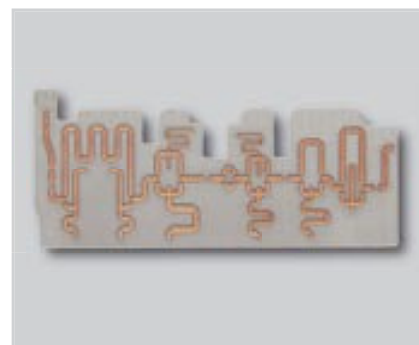

Prepreg

Prepreg is a unique laminate, usually having no conductive layer. Prepreg is used when making multilayer boards to act as a barrier between conductive layers. The heat and pressure of the multilayering process cures the prepreg and it acts as both insulation and a seal between two different layers of base material.

- Plotters
- Laser
- Plating
- Multilayer
- SMT/Finishing
- Tech Guide
- Index

Technical Guide

Application review and compatibility grid

LPKF ProtoMat circuit board plotters enjoy a broad range of applications. They work a variety of material – flexible, rigid, dense, soft, etc. In all applications, LPKF ProtoMat circuit board plotters perform flawlessly, creating production-quality work in a fraction of the usual time.

Milling and drilling single- and double-sided circuit boards

The most common application is the production of high quality professional printed circuit boards in a prototyping environment. LPKF ProtoMat circuit board plotters mill tracks and gaps as small as 100 µm (4 mil) and drill holes as small as 150 µm (6 mil). This reproduces a prototype accurately from the original design data, including the precise geometry needed for BGA, fine-pitch SMT, RF, and other applications.

RF and microwave circuits

RF and microwave prototyping requires a variety of special substrates, such as ceramic filled (RO4000®) substrates, and extremely precise trace geometries. LPKF ProtoMat printed circuit board plotters with high speed spindle motors produce exactly this kind of precise cut, with unmatched accuracy. Custom-designed carbide tools create straight sidewalls and reduce penetration into the substrate by the milling head.

Multilayer PCBs up to 6 layers



LPKF circuit board plotters are key components to any application requiring multilayered circuit boards. Fabricate prototypes as complex as six layers using a combination of an LPKF ProtoMat circuit board plotter with a through-hole conductivity system such as the Contac III and a board press such as the MultiPress II.

Contour routing of circuit boards

LPKF ProtoMat printed circuit board plotters can rout any shape from a substrate – straight lines, curves, whatever. If the CAD software can describe it, a ProtoMat can cut it.

Flexible and rigid-flex circuit milling

Process a wide range of flexible and rigid-flexible circuit material using LPKF ProtoMat models equipped with a patented non-contact air bearing foot, such as the S100 and the H100. These models produce the finest results for these technologically challenging substrate combinations.

Application	LPKF ProtoMat				
	S100	S62	S42	H100	M60, X60
 Milling and drilling single- and double-sided circuit boards	✓	✓	✓	✓	✓
 RF and microwave circuits	✓	✓	-	✓	✓
 Multilayer PCBs up to 6 layers	✓	✓	✓	✓	✓
 Contour routing of circuit boards	✓	✓	✓	✓	✓
 Flexible and rigid-flex circuit milling	✓	✓	-	✓	✓
 Front panels/sign engraving	✓	✓	✓	✓	✓
 Machining cut outs in front panels	✓	✓	-	✓	✓
 SMD stencil cutting	✓	✓	✓	✓	✓
 Housing production	✓	✓	-	-	-
 Wave solder pallets	✓	✓	-	-	-
 Depanelization and rework	✓	✓	-	✓	✓
 Test adapter drilling	✓	✓	-	-	-
 Inspection templates	✓	✓	-	✓	✓

Plotters
Laser
Plating
Multilayer
SMT/Finishing
Tech Guide
Index

 **Front panels/sign engraving**
 LPKF ProtoMat circuit board plotters engrave front panels and signs with extraordinary precision, on plastics, Plexiglas, aluminum, brass, and more.

 **Machining cut outs in front panels**
 LPKF ProtoMat circuit board plotters with fast spindle speed motors rout aluminum front panels quickly and easily.

 **SMD stencil cutting**
 In the mass production of SMT circuit boards, the use of polyimide solder masks is critical, driving the precision of solder application and protecting the board from environmental influences.

 **Housing production**
 In addition to flat circuit boards and signs, LPKF ProtoMat circuit board plotters are useful in a prototyping lab when routing out and machining three-dimensional objects, such as housings and pockets in material.

 **Wave solder pallets**
 Wave solder pallets hold PCBs steady during wave soldering. LPKF ProtoMat circuit board plotters with stepper motor Z-axis control are ideal for routing and milling support structures in thick, temperature-resistant plastics.

 **Depanelization and rework**
 An LPKF ProtoMat can be a valuable element in a fast-paced production environment, providing independent depaneling of populated and unpopulated circuit boards. ProtoMat circuit board plotters are also excellent for certain kinds of rework and circuit tuning.

 **Test adapter drilling**
 Bed-of-nails testing platforms require custom fabricated plastic adaptors, and high speed LPKF ProtoMat circuit board plotters with stepper motors controlling the Z-axis are perfect for this application.

 **Inspection templates**
 LPKF ProtoMat circuit board plotters are well suited for the precise machining of solder frames and inspection templates – two crucial elements of quality control in the mass production of printed circuit boards.

Application Notes

LPKF recommends the S100 or H100 when the primary application is RF/microwave.

LPKF recommends the increased accuracy and ease-of-use afforded by the optional fiducial recognition camera (the camera is standard with the H100).

Note that the LPKF MultiPress II, required for pressing 4+ layer boards, has a maximum press area of 420 x 360 mm (16.5" x 14.1").

LPKF recommends the S62, S100 or H100 when 4+ layers are the primary application because the work areas of these devices are complementary with the MultiPress II work area.

Working with flexible substrates requires a vacuum table, an option on the S62 and the S100. A vacuum table is a standard feature of the H100.

LPKF recommends the S100 or S62 for routing aluminum front panels.

Working with flexible substrates requires a vacuum table, an option on the S62 and the S100. A vacuum table is a standard feature of the H100.

LPKF recommends the S100 and S62 for the high clearances necessary for plastic and aluminum housings.

LPKF recommends the S100 and S62 for the stepper-driven milling depth control.

LPKF recommends the S100 and S62 for rework because of the high clearance, however the M60 and X60 will depanel unpopulated PCBs.

LPKF recommends the S100 or S62 for the stepper controlled Z-axis and high clearance.

LPKF recommends an S100 or other high-speed ProtoMat to avoid melting template plastic.

Technical Guide

CAM Software, LPKF CircuitCAM

LPKF's universal CAM software, CircuitCAM PCB, imports design data from virtually every known design package, and allows the user to modify or change the layout on-the-fly. The interface is straightforward and easy to learn:

Front to end tools

Functions generating the milling and drilling actions, such as data import, contour routing, inserting break-out tabs, exporting LMD files, etc.



Step 1: Data Import

CircuitCAM easily imports Gerber, Excellon, DXF, and practically all other file types.



Step 2: Contour Routing

Determine the routing paths for inner and outer routs.



Step 3: Breakout Tabs

Set breakout tabs for small PCBs, to allow for easy depaneling.



Step 4: Set Rubout Areas

Determine the areas of the PCB where copper will be completely removed.



Step 5: Insulation

Set the milling paths and necessary tool choices for the PCB prototype.



Step 6: Export Data to BoardMaster

Export the final edited data to BoardMaster.

1 Standard Windows Toolbar

This toolbar contains all the most familiar Windows tools, including file commands, printer commands, etc.

2 Front to End Tools

Functions generating the milling and drilling actions, such as data import, contour routing, inserting break-out tabs, exporting LMD files, etc.

3 View Tools

Functions involving zooming views in and out of a circuit file, allowing for precision placement and control, and for setting the layer properties.

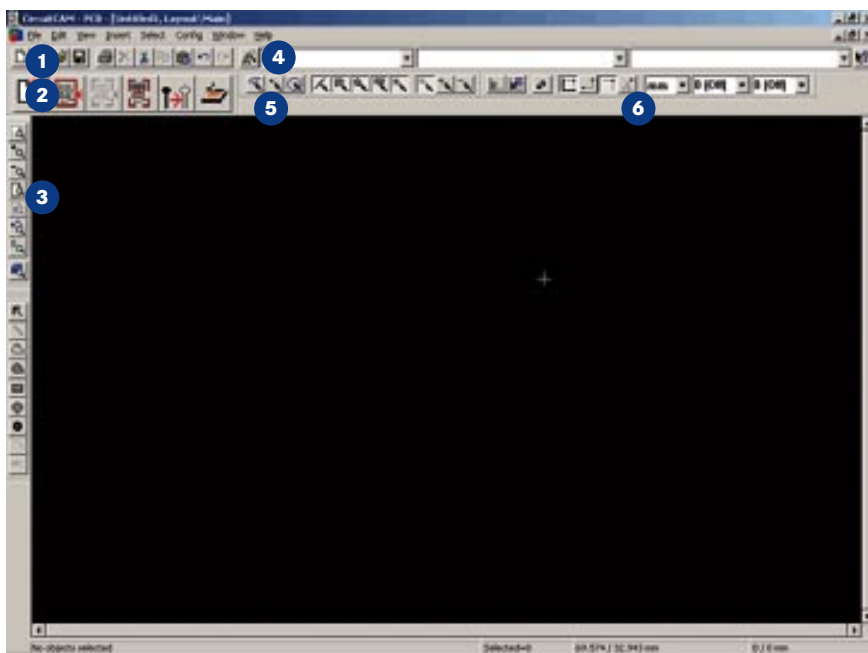

4 CircuitCAM Wizard

The CircuitCAM PCB “Wizard” Function steps the operator through most any CAM preparation.

5 Selection Tools

Tools for marking and manipulating graphical objects.

6 Grid and Unit Tools

Functions controlling layer manipulation, including modifying points-of-origin, units, and grid values.

Technical Guide

Machine control software, LPKF BoardMaster

LPKF's ProtoMat control software, BoardMaster, imports LMD files from CircuitCAM PCB and allows the user to manipulate the final images onto a workpiece – including rotation, moving, tiling, etc. The interface is straightforward and easy to learn:

1 Function Bar

The Function Bar contains the functions and controls for the circuit board plotter.

2 Tool Changing Position (ProtoMat S62 & S100)

Represents the ten tool changing stations for the automatic tool changer.

3 Imaging Window

The live image from the camera (if the system has a camera installed).

4 Fiducial Reference Window

Indicates a fiducial reference point.

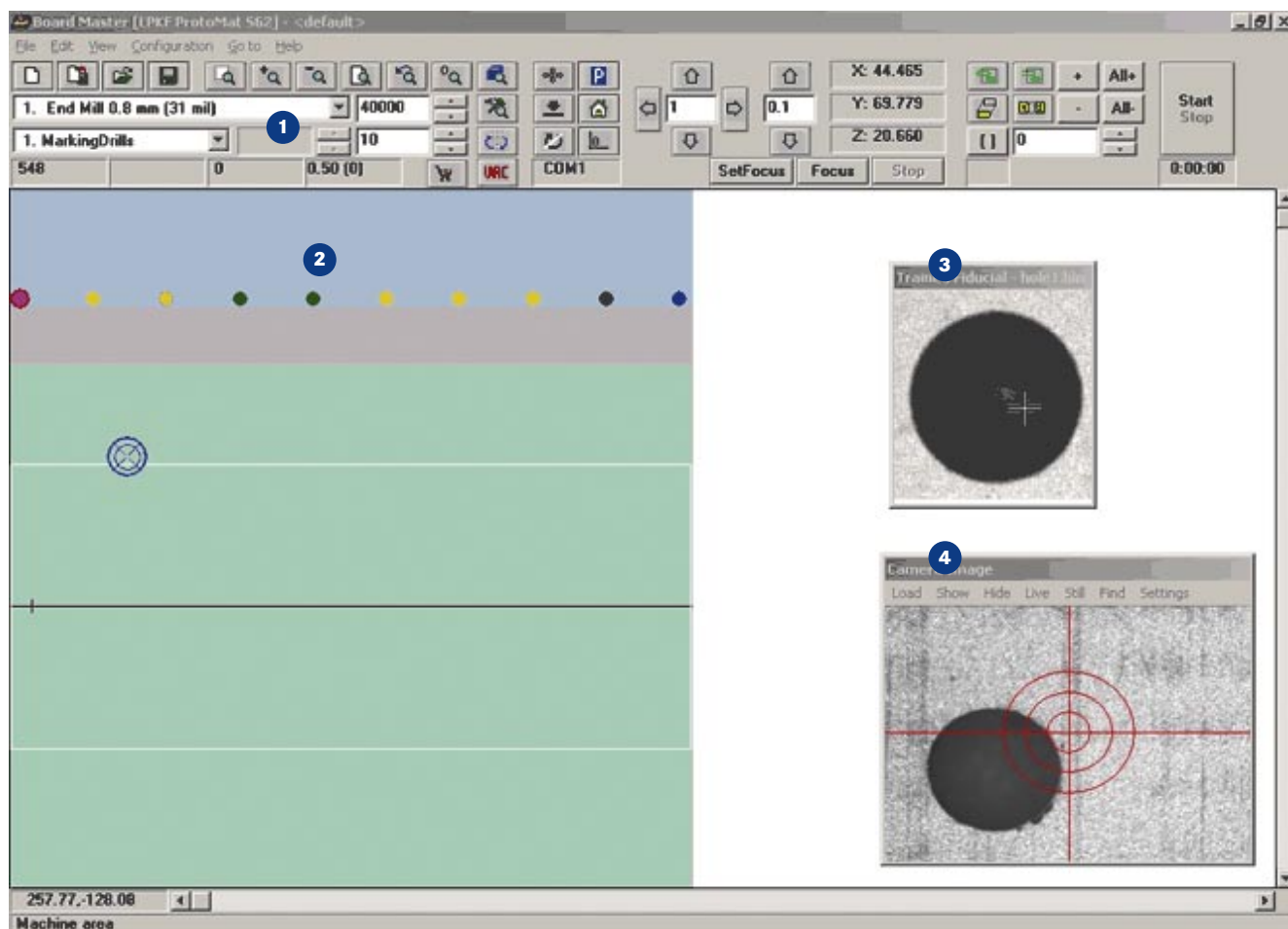

Technical Guide

Building a basic 2-sided PCB prototype, step-by-step

Creating a printed circuit board is a straightforward process using an LPKF ProtoMat circuit board plotter. As an example, the following procedure describes the steps used to create a typical two-sided PCB, complete with through-holes plated using the LPKF ProConduct® system.

Please refer to the ProConduct® tutorial for more information. The Contac III pages/tutorial and EasyContac pages contain more information about those methods of creating through-hole conductivity.

Plotters

Laser

Plating

Multilayer

SMT/Finishing

Tech Guide

Index

1. Import data

LPKF's CircuitCAM software imports a wide variety of data formats – virtually every format capable of designing a circuit board. This includes Gerber®, GerberX, HP-GL™, Excellon®, Sieb & Meier, DXF, Barco®, and ODB++®.

2. Determine Contour Routing, Breakout Tabs, Rubout Areas and Insulation

Use CircuitCAM to determine the Contour Routing (board cutouts), Breakout Tabs (interruptions to the Contour Routs), and Rubout Areas (large areas where copper must be removed). Calculation of milling lines for the LPKF ProtoMat starts with a simple click on the “Insulation” button.

3. Transfer to BoardMaster

When CircuitCAM operations are complete, export this data to an LMD file and re-import into BoardMaster, LPKF's software tool for operating the ProtoMat and for managing PCB prototyping projects.

4. Transform and Save

Use BoardMaster to perform any transformations to the project, such as rotation, duplication, tiling, etc. These transformations may be saved to avoid duplication for future projects.

5. Preliminary Drilling

Drill guide holes (where necessary) for the PCB and drill all holes (such as mounting holes) that will remain unplated.

6. Milling and Routing

In order, mill the bottom of the PCB, the top of the PCB, cut the inside routs of the PCB, and cut the outside routs.

7. ProConduct® First Step

Remove the PCB from the ProtoMat and apply the protective film to both sides. Refer to the ProConduct® tutorial in this section for more information.

8. Drill Plated Holes

Reinstall the board on the ProtoMat, following the necessary procedures to assure alignment, and drill the final holes which are scheduled for plating.

9. Finish ProConduct® Steps

After drilling, remove the PCB from the ProtoMat and complete the steps outlined in the ProConduct® tutorial. This includes applying the conductive polymer, vacuuming the holes clear, curing the board, and a final wash. After drying, the PCB is immediately ready for use.

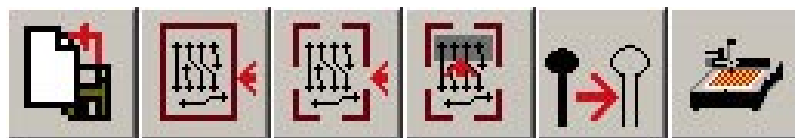

Process steps with LPKF CircuitCAM

Process steps with LPKF BoardMaster

Technical Guide

Chemical free through-hole plating, step-by-step

The LPKF ProConduct® through-hole conductivity system is an ideal solution for many in-house rapid PCB prototyping environments. ProConduct® is perfect for low volume production, laboratories or shops where chemical electroplating is impractical, or any circumstance requiring an economical through-hole conductivity solution.

1. Protective film

After milling and cleaning the finished PCB, roll the LPKF Protection Film onto both sides of the PCB.

2. Drilling

Drill the through-holes using a ProtoMat circuit board plotter.



3. Prepare table

With a thin layer of fleece protecting the vacuum table, place the drilled PCB on the table, using the covering film cutout to block airflow from areas other than the PCB.



4. Coat side 1

Knead the conductive polymer to soften it and apply evenly to the entire surface of the board using a squeegee. Be sure to fill every hole.



5. Apply suction

Switch on the vacuum table. Continue moving the polymer over the surface until all of it has been pulled through the drill holes.



6. Verify and repeat for side 2

Switch the vacuum table off and verify that the polymer has properly coated the holes. Repeat for the other side of the PCB.



7. Curing

Carefully remove the protective film from both sides of the PCB and cure the board for thirty minutes in a 160 °C (320 °F) hot air oven.

8. Final prep

After the cooldown period, wash the board with the ProConduct® cleaner, then with warm running water. After drying, the board is ready for use.

Technical Guide

Galvanic through-hole plating, step-by-step

The LPKF Contac III and MiniContac S are electroplating solutions ideal for any rapid PCB prototyping situation, identical in all but scale to professional PCB electroplating systems.

LPKF has automated the plating process as much as possible, using a step-by-step menu-driven system to walk a user through every step of the process. No particular chemistry background is necessary to operate a Contac III or MiniContac S – the instructions are simple and straightforward:

1. Washing and degreasing

The printed circuit board is washed and degreased in a cycle of baths to make absolutely sure that all contaminants are cleared away and that the electroplating process will function as cleanly as possible.

2. Activator application

A carbon activator is applied to the printed circuit board, adhering to all surfaces scheduled for plating.

3. Electroplating

The LPKF electroplating sequence includes full digital control over the process. User interaction is kept at an absolute minimum – the PCB is simply loaded in and the computer controls the rest of the process.

4. Final cleaning

The final step of the process is a last cleaning of the PCB. After the printed circuit board is dry from the final rinse, it is ready for production. The total process requires two to three hours.

Reverse pulse plating

The Contac III features Reverse Pulse Plating. For through-holes with especially high aspect ratios, reverse pulse plating assures a consistent, even coverage of conductor along the entire inner plated surface:

Typical electroplating

Typical electroplating uses current flowing in one single direction to perform the copper deposition.

Reverse Pulse Plating

With Reverse Pulse Plating, the typical electroplating process is interrupted by brief current reversals. This prevents dimensional copper build-up that can cause trouble with high aspect ratio holes.

Technical Guide

A 6-layer multilayer PCB, step-by-step

The LPKF MultiPress II bonds multiple circuit layers, constructing a multilayered prototype in one pressing, creating a prototype the quality of which is indistinguishable from a production board.

Creating a multilayer board is simply a matter of creating single- and double-layer boards and sandwiching them appropriately. Review and practice making a double-sided

board and familiarize yourself with basic board construction prior to starting the multilayer process.

Multilayer projects use a thinner FR4 substrate – typically 0.5 mm (20 mil) – preventing the final project from being too thick. Multiple layers are separated by a 0.15 mm (6 mil) layer of prepreg laminate, an adhesive insulation activated and cured by the heat and pressure of the MultiPress II.

The example below shows the step-by-step process for creating a six-layer Prototype PCB:

1. Layer 2 & 3 prep

Using an LPKF ProtoMat circuit board plotter, mill the double-sided board for layers 2 and 3. Drill only the fiducial recognition and MultiPress II alignment holes.

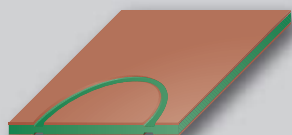

2. Layer 4 & 5 prep

Using an LPKF ProtoMat printed circuit board plotter, mill the double-sided board for layers 4 and 5. Drill only the fiducial recognition and MultiPress II alignment holes.

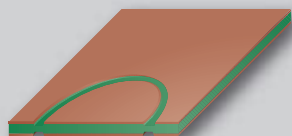

3. Bonding

As per the illustration, layer the elements with prepreg laminate, in the MultiPress II, using the pinholes for alignment. Heat and press the prototype using one of the preprogrammed profiles, or via manual programming.

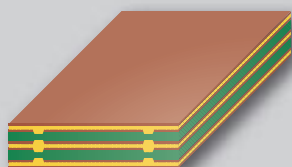

4. Final drilling

Drill the component and via through-holes using the ProtoMat circuit board plotter.

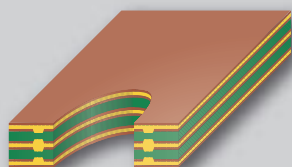

5. Hole plating

Through-hole conductivity for multilayer boards up to four layers can be completed using the LPKF ProConduct® system or the Contac III/MiniContac S galvanic electroplating processes. Five or more layers must be plated.

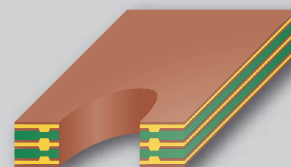

6. Layer 1 & 6 prep

Using an LPKF ProtoMat printed circuit plotter, mill top and bottom layer (1 and 6) like a double sided PCB.

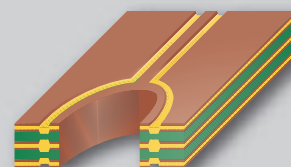

7. Surface finish

Perform any final cleaning, solder mask (LPKF ProMask), etc.

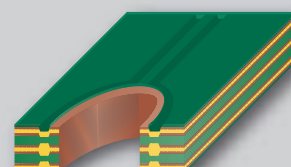

Technical Guide

LPKF ProMask professional solder mask, step-by-step

LPKF ProMask gives prototype PCB's the professional finish they deserve and enables the soldering of SMD or conventional components without concern about short circuits.

Apply the solder-resist mask in four simple steps:

1. Produce the artwork

Produce the artwork template by printing it from LPKF CircuitCAM on a standard laser printer (for best results use 600 or 1,200 dpi).



2. Apply the solder-resist lacquer

Mix the lacquer using the single portion packets of lacquer and hardener. Apply it to the finished prototype PCB using a disposable roller. After application, pre-dry the PCB for 10 minutes in the hot-air oven.



3. Expose PCB with the artwork

Place the PCB in the image exposure unit and place the artwork over it using registration marks. Switch the exposure unit on for thirty seconds, then remove the board and pull away the artwork film.



4. Develop and harden the solder-resist mask

Prepare a bath of developer from the developer powder and ordinary hot water. Immerse the PCB in the bath and remove the non exposed resist by gently brushing. Rinse the lacquer residue away with flowing water, and then harden the resist for another thirty minutes in the hot-air oven. After this final sequence, clean the PCB with LPKF Cleaner and rinse with water.



Technical Guide

Surface Mount Technology (SMT), step-by-step

Surface Mount Technology (SMT) offers significant advantages over traditional through-hole technology. Probably the most significant advantage is size. Surface Mount Devices (SMDs) are much smaller than their through-hole counterparts, as well as lighter, making them ideal for small projects such as mobile devices, telephones, etc. SMDs also are less electrically noisy because of

the shorter interconnect paths, which makes them ideal components for high frequency circuitry, such as microwave and RF work.

LPKF offers a suite of tools ideally suited for fabricating SMT prototypes in-house, a process that can drastically reduce the time-to-market of any design.

Refer to the User Manual for each device for more detailed directions. In general, the process is:

1. Create the physical circuit board

Mill the circuit board using the ProtoMat circuit board plotter. LPKF recommends the ProtoMat S100 or H100 to meet the high geometric tolerances and small detail requirements of SMT circuitry. Use the LPKF ProMask system to apply a solder-resistant insulative mask. This also protects the circuit board.

2. Create the solder paste stencil

Using the ProtoMat circuit board plotter, create a solder paste stencil from polymer film.

3. Prepare the stencil printer

Attach the solder paste stencil and the printed circuit board to the LPKF ZelPrint LT 300 manual stencil printer.

4. Apply solder paste

Using the ZelPrint LT300, apply a smooth, even layer of solder paste in only the precisely needed locations.

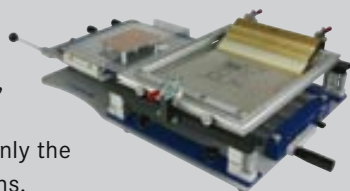

5. Populate the PCB

Populate the printed circuit board using the LPKF ProtoPlace. This desktop professional pick & place assembly system combines a simple control system, integrated camera, and a digital display system to position components exactly where they need to be.



6. Reflow soldering

The final step in the production of a prototype SMT board is soldering, using the LPKF ProtoFlow, a solder paste reflow oven. The temperature profile heats the populated board just hot enough to cause the solder paste to liquefy and solder the components into location. After the cooling cycle, the board is ready to test or use or, if necessary, depanel.

Technical Guide

Microwave and RF application notes

LPKF manufactures tools and supplies that are perfect for producing in-house rapid PCB prototype boards addressing the strict requirements of the RF and microwave industries. In a fraction of the time, prototypes can be manufactured, tested, and retuned as needed, reducing significantly the time-to-market of new products.

Unlike typical applications however, RF and microwave work demand certain considerations for the highest quality results:

Machines

LPKF produces three systems that are ideally suited for situations where RF and microwave applications are the primary application. Both the ProtoMat S100 and the ProtoMat H100 are ideal for mechanical RF and microwave structuring. Both machines feature a high speed 100,000 spindle motor, which produces the kind of clean vertical geometry required by “soft” RF base material. The third system, the ProtoLaser 200, uses a laser to produce much finer structures where required, and is good for small to medium run productions, as well as fine prototyping.

Tooling

LPKF’s special RF package of top quality carbide cylindrical end mills produce excellent cuts and mills, and nearly perfect perpendicular circuit walls.

Sensitivity

Even the smallest scratch or scuff on a conductor trace can affect the response of an RF circuit, so LPKF recommends the pneumatic non-contact working depth limiter. This device floats the head above the work surface without physical contact. Only the actual milling tool comes into contact with the work material.

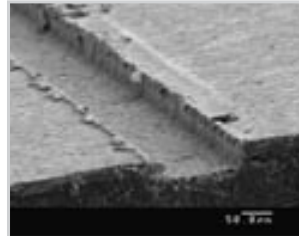

Geometry from End Mill RF tool

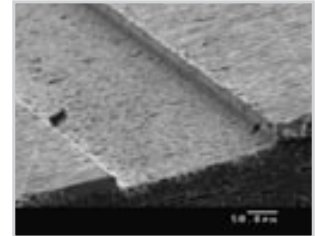

Geometry from normal End Mill tool

Ceramics

Many RF and microwave applications require ceramic or similar substrates. The LPKF ProtoLaser 200 is the best tool for structuring fine details on ceramic or similar substrates.

Flex-circuits

For circuitry placed on flexible or semi-flexible substrates, LPKF recommends using a vacuum table to hold material flush to the table. For some ProtoMats, a vacuum table is an easy-to-add accessory, for other models, it’s a standard feature.

Alignment

For applications using both sides of the substrate, LPKF recommends that the circuit board plotter be fitted with a Fiducial Recognition Camera. This camera assures a precise front-to-back alignment of the circuits.

Software control

When working RF or microwave applications using LPKF’s BoardMaster software, be certain to select the special RF tool library. This makes sure that BoardMaster chooses the correct feed rates and motor speeds for optimal tool life as well as superior cut quality.

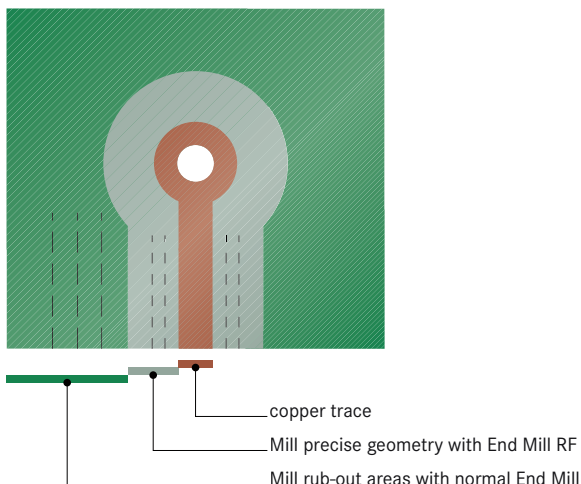

Technical Guide

Plastic and aluminum engraving

LPKF ProtoMat Circuit Board Plotters are also excellent at milling, drilling and routing plastics and soft metals.

Machines

Although every circuit board plotter can mill, drill and rout plastics and soft metals, LPKF recommends using the highest RPM motors for the best results. High RPM spindle speeds (such as the S100 and the H100 motors) cut faster and produce a cleaner cut than slower speed spindles. LPKF does not recommend the S42 for milling soft metals, suggesting the S62 or higher RPM systems instead.

Substrates

LPKF Circuit Board Plotters can mill most any rigid plastic (anything close to FR4 material) or soft metal (such as aluminum or brass). This includes engraving of all sorts, milling bend lines, drilling mounting holes, and completely routing any shape (depending on the depth of the workpiece, a full rout may take several passes). Although LPKF ProtoMats cannot engrave alumina type substrates (fired ceramics), TMM (a synthetic substitute) can be easily milled. Successful tests have also been performed on ESD safe plastics.

Software Control

When working aluminum or other soft metals using LPKF's BoardMaster software, be certain to select the special aluminum tool library. This makes sure that BoardMaster chooses the correct feed rates and motor speed for optimal tool life and superior cut quality.

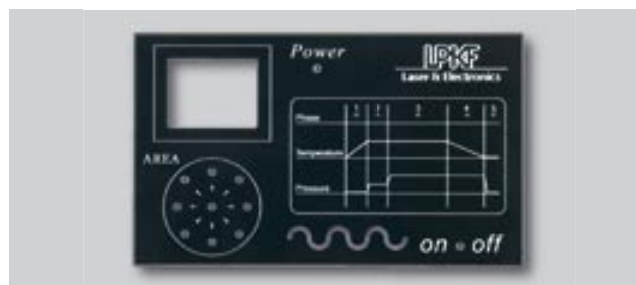

Plotters

Laser

Plating

Multilayer

SMT/Finishing

Tech Guide

Index

Glossary

A

Activating

A treatment that renders nonconductive material receptive to electroless deposition. Non preferred synonyms: Seeding, Catalyzing, and Sensitizing.

Annular Ring

The conductive foil and plating surrounding a hole.

Aperture

A description of the shape and size of the tool used to create a pad or track. The term comes from the days of vector photoplotters, where film was exposed by shining light through apertures (shaped holes) arrayed around the edge of a disk (or "aperture wheel"). Each aperture corresponded to a different D code in the Gerber data. Today, photoplotters use lasers to expose the film but the term "aperture" persists.

Aperture List

A list of the shapes and sizes for describing the pads and tracks used to create a layer of a circuit board.

Artwork

A phototool used to create the different layers during printed circuit board manufacture.

Artwork Master

An accurately scaled (usually 1:1) pattern which is used to produce the production master.

Aspect Ratio

The ratio of the circuit board thickness to the smallest hole diameter.

B

B-Stage Material

Sheet material impregnated with a resin cured to an intermediate stage (B-stage resin). Prepreg is the preferred term.

Backplanes and Panels

Interconnection panels into or onto which printed circuits, other panels, or integrated circuit packages can be plugged or mounted.

Bare Board

A finished PCB that has had no components added.

Barrel

The cylinder formed by plating through a drilled hole.

Base Laminate or Base Material

The substrate material upon which the conductive pattern may be formed. The base material may be rigid or flexible.

"Bed-of-Nails"

A method of testing printed circuit boards that employs a test fixture mounting an array of contact pins configured so as to engage plated-through holes on the board.

Blind-Via

A via hole that does not pass completely through the printed circuit board. A blind via starts from one side or another.

Bond Strength

The force per unit area required to separate two adjacent layers of a board by a force perpendicular to the board surface.

Bridging

A buildup of solder between tracks or pads causing a short circuit.

Buried-Via

A mechanically or laser drilled hole which interconnects internal layers only. It is not electrically connected to any external layer.

C

C-Stage

The condition of a resin polymer when it is in the solid state, with high molecular weight, being insoluble and infusible.

Center-To-Center Spacing

The nominal distance between the centers of adjacent features or traces on any layer of a printed circuit board.

Chamfer

A corner which has been rounded or angled to eliminate an otherwise sharp edge.

Circuit

The interconnection of a number of devices in one or more closed paths to perform a desired electrical or electronic function.

Circuit Layer

A layer of a printed board containing conductors, including ground and voltage planes.

Clad or Cladding

A relatively thin layer or sheet of metal foil which is bonded to a laminate core to form the base material for printed circuits.

Clearance Hole

A hole in the conductive pattern larger than, but concentric with, a hole in the printed board base material.

Coefficient of Expansion, Thermal

The fractional change in dimension of a material for a unit change in temperature.

Component Hole

A hole used for the attachment and electrical connection of component terminations, including pins and wires, to the printed circuit board.

Component Side

That side of the printed circuit board on which most of the components will be mounted.

Conductive Pattern

The configuration or design of the conductive material on the base laminate. Includes conductors, lands, and through connections.

Conductor Base Width

The conductor width at the plane of the surface of the base material.

See also: *Conductor Width*

Conductor-To-Hole Spacing

The distance between the edge of a conductor and the edge of a supported or unsupported hole.

Conductor Spacing

The distance between tracks on a printed circuit board.

Conductor Width

The observable width of the pertinent conductor at any point chosen at random on the printed circuit board.

Controlled Impedance

The process that gives a circuit the correct impedance value. The design engineer will specify the track impedance required. From this, a suitable manufacturing build will be chosen to the suit track widths and layer spacings on the design to meet the required impedance.

Copper Foil

A cathode-quality electrolytic copper used as a conductor for printed circuits. It is made in a number of weights (thicknesses); the traditional weights are 1 and 2 ounces per square foot (0.0014 and 0.0028 inch thick).

Current-Carrying Capacity

The maximum current which can be carried continuously, under specified conditions, by a conductor without causing degradation of electrical or mechanical properties of the printed circuit board.

D**Datum Reference**

A defined point, line, or plane used to locate the pattern or layer for manufacturing, inspection, or for both purposes.

Deburring

Process of removing a burr after board drilling. Deburring operations fall into two categories: producing a clean, sharp edge when removing heavy burr; and radiusing the edge of the holes to prevent build-up in plating.

Design Rules Check

A computer aided program used to check the manufacturability of the circuit board. The checks include track to track gaps, track to pad gaps, annular ring sizes, track to board edge gaps, acid trap detection, unterminated track checks.

DFM

Design For Manufacture.

Dielectric

An insulating medium which occupies the region between two conductors.

Dielectric Constant

That property of a dielectric that determines the electrostatic energy per unit volume for unit potential grade.

Digitizing

Any method of reducing feature locations on a flat plane to digital representation in X-Y coordinates.

Dimensional Stability

A measure of dimensional change caused by factors such as temperature, humidity, chemical treatment, age, or stress; usually expressed as units/unit.

Double-Sided Board

A printed board with a conductive pattern on both sides, but no inner layers.

Drill Table

A description of the drill sizes used to create the circuit board. The drill equivalent of an aperture list.

E**Edge Connector**

The portion of the PCB used to provide external electrical connection, normally gold plated.

Electroplating

The electrodeposition of a metal coating on a conductive object. The object to be plated is placed in an electrolyte and connected to one terminal of a d-c voltage source. The metal to be deposited is similarly immersed and connected to the other terminal. Ions of the metal provide transfer to metal as they make up the current flow between the electrodes.

Etching

The process of removing unwanted metallic substance (bonded to a base) via chemical, or chemical and electrolytic means.

F**Fiducial**

A feature of the printed circuit board used to provide a common measurement point for all steps in the assembly process.

Flash

A pad. Another term dating from the days of vector photoplotters – tracks were drawn, pads were “flushed”. See also pad. “Flash” is also a term used to describe excess material squeezed out between mold pieces during a casting.

Flux

A substance used to promote or facilitate fusion, such as a material used to remove oxides from surfaces to be joined by soldering or welding.

Foil

A thin sheet of metal, usually copper or aluminum, used as the conductor for printed circuits. The thinner the foil, the lower the required etch. time. Thinner foils also permit finer definition and spacing. See Copper Foil.

FR-4

The standard glass epoxy substrate.

Fused Coating

A metallic coating (usually tin or solder alloy) which has been melted and solidified forming a metallurgical bond to the base material.

G**Gerber Data**

A type of data that consists of graphics commands, usually describing how to draw a picture of a circuit. Intended for directing a photoplotter, it is the most common format for data transfer from PCB CAD systems to the manufacturing process. Gerber data is officially designated as RS-274-D (without embedded aperture codes) and RS-274-X (with embedded aperture codes).

Ground Plane

A conductor layer, or portion of a conductor layer, used as a common reference point for circuit returns, shielding, or heat sinking.

H**HP-GL™**

Hewlett Packard Graphics Language.

I**Internal Layer or Inner Layer**

A conductive pattern which is contained entirely within a multilayer printed board.

L**Laminate**

A product made by bonding together two or more layers of material.

Lamination

The process of preparing a laminate; or a multilayer PWB.

Land

A portion of a conductive pattern usually, but not exclusively, used for the connection and/or attachment of components. Also called Pad, Boss, Terminal area, Blivet, Tab, Spot, or Donut.

Layer-To-Layer Spacing

The thickness of dielectric material between adjacent layers of conductive circuitry in a multilayer printed circuit board.

Legend

A format of lettering or symbols on the printed board; e.g., part number, component locations, and patterns.

M**Mask**

A material applied to enable selective etching, plating, or the application of solder to a printed circuit board.

Microsectioning

The preparation of a specimen for the microscopic examination of the material to be examined, usually by cutting out across-section, followed by encapsulation, polishing, etching, staining, etc.

Mil

1/1,000 of one inch, or 0.001".

Minimum Annular Ring

The minimum metal width, at the narrowest point, between the circumference of the hole and the outer circumference of the land. This measurement is made to the drilled hole on internal layers of multilayer printed circuit boards and to the edge of the plating on outside layers of multilayer boards and double-sided boards.

Minimum Electrical Spacing

The minimum allowable distance between adjacent conductors that is sufficient to prevent dielectric breakdown, corona or both, between the conductors at any given voltage and altitude.

Misregistration

The lack of conformity between two or more patterns or features.

Mixed Technology

Describes the assembly process used when pin through-hole, surface mount, and other mounting technologies on the same printed circuit board.

Multilayer Printed Circuit Boards

Printed circuit boards consisting of three or more conducting circuit planes separated by insulating material and bonded together with internal and external connections to each level of the circuitry as required.

N**Nick**

A cut or notch in a track or pad.

O**Open**

A loss of electrical continuity caused by a break in a track.

P**Pad**

The portion of the conductive pattern on printed circuits designated for the mounting or attachment of components. Also called Land.

Panel

The base material containing one or more circuit patterns that passes successively through the production sequence and from which printed circuit boards are extracted. See Backplanes and Panels.

Panel Plating

The plating of the entire surface of a panel (including holes).

Pattern Plating

Selective plating of a conductive pattern (including holes).

PCB

Printed Circuit Board

Photo Plot

A high accuracy laser plotting system. It is used to produce actual size master patterns for printed circuit artwork directly on dimensionally-stable, high contrast silver halide photographic film.

Photoplotter

A device for generating photographic images by directing a controlled-light beam that directly exposes a light-sensitive material.

Photoresist

A light sensitive liquid or a film, which when selectively exposed to light, masks off areas of the design that can then be etched away.

Plated-Through Hole (PTH)

A hole with the plated copper on its sides to provide electrical connections between conductive patterns at the levels of a printed circuit board.

Plating, Electroless

A method of metal deposition employing a chemical reducing agent present in the processing solution. The process is further characterized by the catalytic nature of the surface which enables the metal to be plated to any thickness.

Plating, Electrolytic

A method of metal deposition employing the work or cathode; the anode the electrolyte, a solution containing dissolved salts of the metal to be plated; and a source of direct current. (See Electroplating)

Plating Resists

Materials which, when deposited on conductive areas, prevent the plating of the covered areas. Resists are available both as screened-on materials and as dry-film photopolymer resists.

Plotting

The mechanical converting of X-Y positional information into a visual pattern, such as artwork.

Polyimide Resins

High temperature thermoplastics used with glass to produce printed circuit laminates for Multilayer and other circuit applications requiring high temperature performance.

Prepreg

Sheet material consisting of the base material impregnated with a synthetic resin, such as epoxy or polyimide, partially cured to the B-stage.

PWT

Printed Wiring Technologies

R**Reflowing**

The melting of an electro-deposit followed by solidification. The surface has the appearance and physical characteristics of being hot-dipped.

Registration

The degree of conformity of the position of a pattern, or a portion thereof, with its intended position or with that of any other conductor layer of a board.

Resist

Coating material used to mask or to protect selected areas of a pattern from the action of an etchant, solder, or plating. Also see: Dry-Film Resists, Plating Resists and Solder Resists.

Router

A machine that cuts away portions of the laminate to leave the desired shape and size of a printed circuit board.

S

Schematic Diagram

A drawing which shows, by means of graphic symbols, the electrical connections, components and functions of an electronic circuit.

Scoring (V-Scoring)

The panels are precision cut through both sides of the panel to a preset depth. The panels remain rigid for assembly but are ready for breaking into individual circuits.

Screen Printing

A process for transferring an image to a surface by forcing suitable media through a stencil screen with a squeegee. Also called Silk Screening.

Single Sided Board

A printed circuit board that contains tracks and pads on one side of the board and no plating in the through holes.

SMT

Surface Mount Technology

Solder Leveling

The process of dipping printed circuit boards into molten solder and leveling the surface with hot air.

Solder Mask or Resist

Coatings which mask and insulate portions of a circuit pattern where solder is not desired.

Solder Side

On printed circuit boards with components on only one side, the side of the PCB that is opposite to the component side.

Surface Mount Technology (SMT)

The components are mounted on the surface of a circuit board rather than inserting components into plated through holes.

T

Tester

A device that checks a PCB for the connectivity of its circuits from the design netlist.

Thin Foil

A metal sheet less than 0.0007 inches (1/2 oz) thick or less.

Tooling Holes

The general term for non-plated holes placed on a printed circuit board or a panel used for registration and tooling purposes during the manufacturing process, testing and assembly.

Track

An electrical connection between two or more points on a PCB.

U

UL (Underwriters Laboratory)

A U.S. safety standard certification organization.

UV (Ultraviolet)

Curing Polymerizing, hardening, or cross linking a low molecular weight resinous material in a wet coating or ink, using ultraviolet light as an energy source. Ultrasonic Cleaning Equipment Equipment used for ultrasonic immersion cleaning employing a transducer which converts electrical energy into mechanical energy; an ultrasonic generator, and a tank to contain the cleaning liquid. Both automated and conveyORIZED ultrasonic cleaning systems exist.

V

Via or Via Hole

A plated-through hole used as a through or inner-layer connection, but in which there is no intention to insert a component lead. These holes are generally the smallest as no components are inserted in them.

W

WYSIWYG

What You See Is What You Get. This term describes a computer interface that reflects an actual physical object, as opposed to a more symbolic representation. For example, early word processing programs produced a final printed output that was very different than what appeared on the editing screen, but later programs appeared on the editing screen exactly as they were expected to print

Index

- 2-layer printed circuit boards** 9, 59
- 4-layer printed circuit boards** 9, 39
- 6-layer printed circuit boards** 9, 21, 39, 57, 63, 97
- Accessories** 29
- Acoustic cabinet 6, 30
- Adhesive tape 40
- Alignment 100
- Applications 6, 90, 100
- Assembly 75
- Automatic tool change 5, 8, 12, 20, 93
- Autoswitch 31
- Base material** 39, 40, 89
- Basic construction of a 2-sided PCB... 94
- BGA (Ball Grid Array) 90-91
- Bits see Tools
- BoardMaster 41, 43
- Brush head 31
- CAD Software** 41, 90
- CAM Software 41, 92
- Camera, fiducial recognition 30
- Ceramic 21, 47, 89, 100
- Chemical tinning 57
- Chemical-free 49, 51, 59, 79, 97
- Chemicals 58
- Circuit board plotters see ProtoMat
- CircuitCAM Lite 41
- CircuitCAM PCB 41
- CircuitMaster 41
- Cleaning pad 28, 40
- Compressor 32
- Conductive polymer 51, 95
- Consumables 37
- Contac III 55
- Contour routing 9, 13, 17, 21, 25, 33, 90
- Copper-clad material 37
- Cut outs 9, 13, 17, 21, 25, 90
- Cutting 6, 27
- Data import/export** 41, 92, 94
- Depaneling 9, 13, 17, 21, 25, 85, 91
- Depth limiter 27, 100
- Depth sensor 19
- Dimensional routing 9, 13, 91
- Distributors 108
- Double sided circuit boards 90
- Drill underlay material 38, 39
- Drilling 6, 33
- Dust extraction 31
- DXF 94
- EasyContac** 59
- Electroplating 51, 55
- Endmill 33, 100
- Engraving 34, 91, 101
- Fiducial recognition camera** 27, 30
- Fine pitch printing 72
- Flexible circuit boards 89, 90
- Flexible substrates 89, 90
- Foils 6, 70
- Front panels 25, 27, 91
- Front-to-back alignment 30
- Gerber** 94
- Head lighting** 8, 12, 16, 20
- Hot air oven 54, 70, 95, 98
- Hotline Cover
- Housings 91
- Image exposure unit** 69, 70, 98
- Inert gas option 79
- In-house prototyping 1
- Inspection templates 6, 91
- Large sized circuit boards** 23
- Laser printer for ProMask 98
- Laser structuring 44
- Lead-free reflow process 79, 81

- M** Measuring microscope 31
 Mechanic stretching frame 73
 Metal engraving 91, 101
 Micro camera 77
 Microcutter 33
 Microwave circuits 19, 44, 91, 100
 Microwave substrates 91,100
 Milling 6, 33, 90
 MiniContac S 55
 Mobile table 64,
 Monitor 77
 Motorized turntable 75
 Multilayer 62, 79, 90, 97
 MultiPress II 63
- O** ODB++ 94
 Online shopping Inside Front Cover
 Options 30
 Order information Inside Front Cover
 Oven 54, 79
- P** PCB Prototyping 6
 Pinhole beds 97
 Plastic foils 6
 Plexiglas 91
 Pneumatic depth limiter 19, 100
 Pneumatic stretching frame 73
 Pockets 6, 91
 Polymer paste 50, 51, 61, 94, 95
 Polymer stencils 71
 Prepreg 39, 40, 62, 89, 97
 Printed circuit board 4, 6, 84, 85, 89
 ProConduct® 49, 51, 97
 ProMask 67, 98
 ProtoFlow 79, 99
 ProtoLaser 44, 100
 ProtoMat 4
 ProtoMat, Feature comparison 27
 ProtoPlace 75, 99
 PTFE 61, 89
- R** Rapid PCB Prototyping 1, 6
 Reflow oven 79, 99
 Request 109
 Reverse pulse plating 55, 61, 96
 RF circuits 11, 19, 23, 44, 47,
 50, 61, 89
 RF endmill 34
 Rigid-flex circuit boards 7, 19, 71, 85, 89
 Ring setter 31
 Routing 6, 90
 RS-232 6
- S** Sales and service Inside Front Cover,
 108
 Sensitive substrates 7, 19, 24
 Sieb & Meier 94
 Signs 9, 13, 25, 91
- Sinter backing plate 39
 Slots 13, 25
 SMD assembly 75
 SMD soldering 7, 98
 SMD stencil cutting 7, 11, 15, 19, 23, 91
 SMT prototyping 66, 71, 91, 99
 SMT solderpaste 71
 Soft metal 24, 101
 Software 41
 Solder masks 67, 98
 Solder paste 66, 71, 75, 81, 99
 Spindle motor 6
 Starter Set 38
 StatusLight 32
 Stencil cutting 7, 11, 15, 19, 23, 91
 Stencil printer 71, 81, 98
 Stick feeders 77
 Substrates 40
 Support Inside Front Cover
- T** Tape feeders 77
 Technology Guide 88
 Test adapters 6
 Three-dimensional routing 9, 90
 Through-hole conductivity 49, 51, 59, 61, 90, 94
 Through-hole plating 51, 55, 61, 95
 Tin plating 57, 61
 Tool change 5, 8, 12, 20, 93
 Tool collet 10, 14, 18, 22, 26
 Tools 28, 33
- U** Universal cutter 33
 USB 6, 27
 UV-exposure 69, 70, 98
- V** Vacuum table 27
 Vision system 49
- W** Wave solder pallets 90-91
 Working depth limiter, pneumatic 7, 8, 19, 20, 21, 24,
 27, 100
- Z** ZelFlex 73
 ZelPrint 43, 71, 81, 99

LPKF Distributors

Australia

Embedded Logic Solutions Pty. Ltd.
Phone +61-2-9793-9542
Fax +61-2-9790-1183
sales@emlogic.com.au
www.emlogic.com.au

Austria

elsinger electronic Handel GmbH
Phone +43-1-9794651-0
Fax +43-1-9794651-24
office@elsinger.at
www.elsinger.at

Brazil

ANACOM Eletronica Ltda.
Phone +55-11-3422-4200
Fax +55 11-3422-4242
inquiries@anacom.com.br
www.anacom.com.br

China

LPKF Tianjin Co., Ltd.
Phone +86-22-23005700
Fax +86-22-23006965
lpkfchina@lpkf.com
www.lpkf.cn

Czech Republic

SE Spezial-Electronic AG, o.s.
Phone +420-233-326621
Fax +420-233-326623
spezial@spezial.cz
www.spezial.cz

Denmark

EUROCHANNELS Danmark A/S
Phone +45-98242444
Fax +45-98244036
info@eurochannels.dk
www.eurochannels.dk

Finland

OY MERVAL Ltd.
Phone +358 9 22191500
Fax +358 9 22191555
merval@nylund.fi
www.merval.fi

France

LPKF France S.A.R.L.
Phone +33-1-6086-2691
Fax +33-1-6086-9622
lpkf.fr@lpkf.de
www.lpkf.fr

Germany

SE Spezial-Electronic AG
Phone +49-5722-203-125
Fax +49-5722-203-120
info@spezial.de
www.spezial.de

Great Britain

LPKF Laser & Electronics Ltd.
Phone +44-1344-455046
Fax +44-1344-860547
sales@lpkf.co.uk
www.lpkf.co.uk

Hungary

Pannoncad Technical Informatics &
Technology Systems House Ltd.
Phone +36-1-350-0214
Fax +36-1-350-0214
benjamin.gaborb@pannoncad.hu
www.pannoncad.hu

India

Bergen Associates Pvt. Ltd.
Phone +91-11-2592 0283
Fax +91-11-2592 0289; -0292
bergen_india@sify.com
www.bergengroupindia.com

Iran

Afriz Farayand Co.
Phone +98-218044882
Fax +98-218044924
aliahmadm@afriz.com
www.afriz.com

Israel

MTI Engineering Ltd. MTI House
Phone +972-3-9008900
Fax +972-3-9008902
shuli_r@mti-group.co.il
www.mtiwe.com

Italy

NITZ electronics GmbH
Phone +39-0472-833944
Fax +39-0472-833943
info@nitz.it
www.nitz.it

Japan

LPKF Japan Co. Ltd.
Phone +81-334657105
Fax +81-334676159
info@lpkf.co.jp
www.lpkf.co.jp

Jordan

International Engineers for Trading
Phone +962 6 551 4648
Fax +962 6 551 9211
ie-est@nol.com.jo

Netherlands

PrintTec Tools for Electronics
Phone +31 345 623444
Phone +31 345 623737
info@printtec.nl
www.printtec.nl

Pakistan

Zeeshan Electronics
Phone +92-51-4449945
Fax +92-51-4449948
zia.sheikh@zeeshanelectronics.com

Poland

SE Spezial-Electronic Sp.z.o.o.
Phone +48-228409110
Fax +48-228412010
marek@spezial.pl
www.spezial.pl

Romania

Interbusiness Promotion &
Consulting S.R.L.
Phone +40-21-3171225
Fax +40-21-3196371
marian.lazurca@interbusiness.ro
www.interbusiness.ro

Russia

All Impex
Phone +7-495-9645164
Fax +7-495-6031312
info@all-impex.ru
www.all-impex.ru

SE Spezial-Electronic AG

Phone +7-095-438-4222
info@spezial.ru
www.spezial.ru

Saudi Arabia

ARAB ENGINEERS
Phone +966-1-4633117
Fax +966-1-4652766
ae@ae.com.sa
www.ae.com.sa

Singapore

HAKKO Products Pte. Ltd
Phone +65-67482277
Fax +65-67440033
sales@hakko.com.sg
www.hakko.com.sg

Slovenia

LPKF Laser & Elektronika d.o.o.
Phone +386-4-20138-06
Fax +386-4-20138-20
info@lpkf.si
www.lpkf.si

South Africa

Cadshop Pty. Ltd.
Phone +27-117893910
Fax +27-117893913
davep@gw.co.za
www.gw.co.za

South Korea

CHUNGPA EMT Co., Ltd.
Phone +82-2-2108-5980
Fax +82-2-2108-5988
sale@chungpaemt.co.kr
www.chungpaemt.co.kr

Spain

LPKF Laser & Electronics Spain S.L.
Phone +34-91-8475505
Fax +34-91-8475522
juan@lpkfspain.com
www.lpkfspain.com

Sweden

SOLECTRO AB
Phone +46-40-536 600
Fax +46-40-536 610
Solectro@Solectro.se
www.solectro.se

Switzerland

Lumatron AG
Phone +41-62-7977580
Fax +41-62-7977581
h.kurth@lumatron.ch
www.lumatron.ch

Taiwan R.O.C.

EMV ENERGY MASS VELOCITY
Co. Ltd.
Phone +886-2-29068117
Fax +886-2-29068387
emv@ms27.hinet.net

Turkey

TAMARA Electronics Ltd.
Phone +90-2164189294
Fax +90-2164189396
emin@tamara.com.tr
www.tamara.com.tr

Ukraine

VD MAIS
Phone +380-44-4928852
Fax +380-44-2873668
lukushin@vdmals.kiev.ua
www.vdmals.kiev.ua

USA

LPKF Laser & Electronics Inc.
Phone +1 (503) 454-4200
Fax +1 (503) 682-7151
info@lpkfusa.com
www.lpkfusa.com

Vietnam

TECAPRO Co.
Phone +84-4-7163914
Fax +84-4-7162452
hoanganhtec@hn.vnn.vn

Request for quote

LPKF distributor

Customer Number

Customer address

Company _____

Phone _____

Division _____

Fax _____

Mr./Mrs. _____

E-mail _____

Street/P.O. Box _____

City, Zipcode _____

State _____

Country _____

Requested delivery date _____

Requested dispatch type _____

Please contact me immediately about the following products:

Item	Part #	Article Description	Quantity

Comments _____

Date/Signature _____

Indicia

Price lists

Any price list inserted or attached to this catalog is not a part of this catalog. All prices subject to change. Contact your nearest Distributor for the most current prices.

Technology note

All specifications are subject to technical modifications.

Privacy policy

LPKF protects client and customer personal and professional information. All such submitted information will be used only by LPKF and not resold or shared with any third party.

Indicia, trademarks, and patents

© 2006 LPKF Laser & Electronics AG, Garbsen, Germany. All rights reserved. Systems and products offered by LPKF and its subsidiaries are protected by issued and pending German and international patents. Any non-LPKF products mentioned are for reference purposes only and may be trademarks or registered trademarks of their respective companies. The LPKF logo and "LPKF ProConduct" are registered trademarks of LPKF Laser & Electronics AG.

LPKF Laser & Electronics AG
Osteriede 7
D-30827 Garbsen
Germany

Phone +49(0)5131-7095-0
Fax +49(0)5131-7095-90

info@lpkf.de
www.lpkf.com

LPKF-Distributor